

USER MANUAL

OUMAN A203

Controller for three circuits

- control for 2 heating circuits
- 1 domestic hot water control



XM1578B: Version 1.0->

This user manual consists of two parts. Issues that are intended for all users are presented in the first part of user manual. The issues related to service mode are at the end of it. In addition there are issues, which are only intended for persons in maintenance or who has in-depth knowledge of the control process. The user manual can also be downloaded from [www.ouman.fi /en/document-bank/](http://www.ouman.fi/en/document-bank/).

The A203 is a heating controller for 3 circuits (two heating circuits and one hot water circuit). Wiring and configuring selections define what is seen on the display screen.

Control knob and OK



Press the control knob to enter the menu and accept the changes.

Turn the control knob to navigate in the menu.

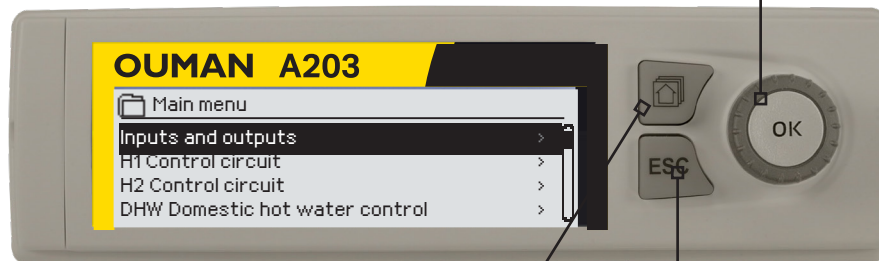

You can move from one info view to another by pressing the key.

Cancel button

By pressing the ESC button, the controller returns to the previous menu and if you edit settings you can cancel the setpoint change.

Holding the key down for an extended period of time returns the regulator to its basic mode. The display shows the basic view, the background light of the display dims and the keyboard locks if the locking function is in use.

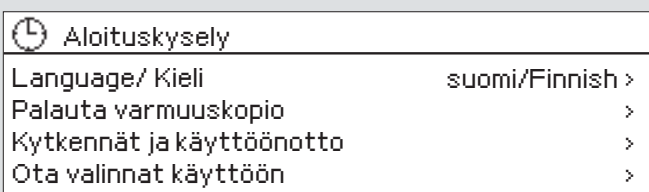
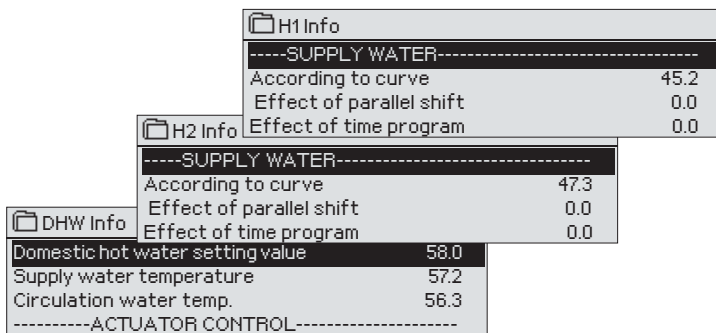

Press OK. Select language and press OK. The device restart.

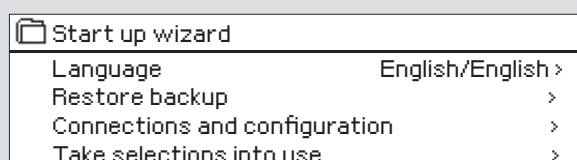

- More information see page 27
- More information see page 47
- More information see page 37
- More information see page 47

Contents

1 Display menus	4
1.1 Basic view	4
1.2 Alarm notice	5
1.3 Menu structure	6
2 Inputs and outputs	7
3 Regulation of supply water in heating circuits	9
3.1 Info	9
3.2 Heating curve	11
3.3 Setting values	13
3.4 Control mode	14
3.5 Time programs	15
3.5.1 Weekly schedule	15
3.5.2 Exception schedule	16
3.5.3 Special days	16
3.5.4 Temp. level according to time program	16
4 Domestic hot water control	17
4.1 Time programs	19
5 Relay 5 and relay 6 control	21
6 Trends	23
7 Alarms	24
8 System settings	27
8.1 Setting date, time and language	27
8.2 Text message (SMS) settings	28
8.3 Network settings	29
8.4 Display settings	32
8.5 Type information	32
8.6 Lock code	32
9. Connection guide	33
9.1 Connections and configuration	37
10 Service settings	41
11 Restore settings and updates	47
11.1 Update the software	48
12 Remote control options	48
12.1 Text message use	49
12.2 WEB user interface	50
Optional accessories	51
Product information and type label	52
Warranty information	53
Product disposal	54
Index	55
Tecnical information	56

1 Display menus

Different levels of display menus are used to make the A203 clear and easy to use. The basic view shows the most important information for monitoring operation of the unit. Favourite views that can be changed by users enable them to easily access desired menus. Setting values needed by the user can easily be found in the versatile menu structure.

1.1 Basic view

Central factors related to controlling heating are visible in the regulator's basic view. When the unit is idle state (keys have not been touched for a while) the display shows the basic view.

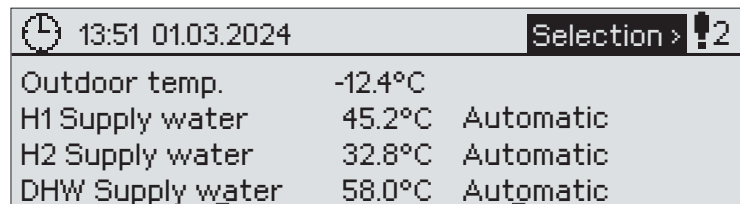

🕒 13:51 01.03.2024	Selection > 🔋 2	
Outdoor temp.	-12.4°C	
H1 Supply water	45.2°C	Automatic
H2 Supply water	32.8°C	Automatic
DHW Supply water	58.0°C	Automatic

Temperature measurements enable quickly determining proper operation of the circuit.

Circuit control. This shows whether the circuit's heating level has been continuously forced to a particularly level or if the controller is in manual mode.

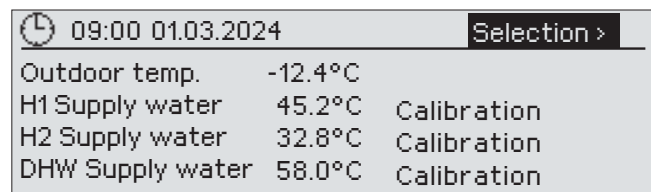

🕒 09:00 01.03.2024	Selection >	
Outdoor temp.	-12.4°C	
H1 Supply water	45.2°C	Calibration
H2 Supply water	32.8°C	Calibration
DHW Supply water	58.0°C	Calibration

The calibration time is always performed when the controller is started and every Monday at 9.00. The calibration duration is 1.1 times the actuator running time. The calibration run can be disabled if desired (see page 41).

1.2 Alarm notice

13:51 01.03.2024	Selection > 2	
Outdoor temp.	-12.4°C	
H1 Supply water	45.2°C	Automatic
H2 Supply water	32.8°C	Automatic
DHW Supply water	58.0°C	Automatic

Alarm indication

- A blinking exclamation point means the unit has active alarms.
- The number indicates the number of active alarms.

 The symbol indicates that all alarms are disabled.

Ouman A203 can generate alarms for several different reasons. In the event of an alarm, an alarm window pops up showing detailed alarm information and a beeping alarm signal goes on, if the alarm sound is not turned off (see page 27).

If there are several unacknowledged alarms, the latest activated alarm is always shown in the display. As soon as all active alarms have been acknowledged, the alarm window disappears and the alarm signal goes off.

 H1 supply water deviation alarm
PR 1 GROUP 1 A203.G1010,TE41.DA1
H1 Supply water temp. =10.2 °C
Received: 08.02.2024 02:27
Press OK to acknowledge the alarm

Alarm signal of all active alarms may also be muted by pressing Esc button. When you press Esc, the alarm signal stops and the last alarm windows disappear from the display.

You may look into the alarms later by going to "Alarms" > "Active alarms". If an alarm has not been acknowledged, an exclamation mark will appear in the beginning of the row.



When controller is configured, it's possible to disable alarms. When the alarms are disabled, the symbol will be displayed in the main menu. Alarms are enabled in the service mode -> Alarm settings -> Alarms: Disabled/Enabled.

Acknowledging alarms: Press OK and the alarm sound will be muted. If the reason for the alarm is still present, the exclamation point in the top right will continue to blink. 

1.3 Menu structure

Main menu
Inputs and outputs
H1 Control circuit
H2 Control circuit
DHW Domestic hot water control
Relay 5 control
Relay 6 control
Trends
Alarms
System settings
Service

Service
The service mode is for the professional service persons and it includes information and parameters which are not needed on daily basis. The service code must be given in order to access the service menu.

In the user manual

Page 7

Inputs and outputs
Home/Away mode
Outdoor temp.
H1 Supply water
H1 Return water temperature
H1 Room temperature
H2 Supply water
...

Page 9

H1 Control circuit
Info
Heating curve
Setting values
Control mode
Time programs

Page 9

H2 Control circuit
Info
Heating curve
Setting values
Control mode
Time programs

Page 17

DHW Domestic hot water control
Info
Setting values
Control mode
Trend display
Time programs

Page 21

Relay 5 control
Function
Setting value
Outdoor temp.
R5 Control (81, 82)

Page 21

Relay 6 control
Function
Temperature limit 1
Temperature limit 2
Time program
Outdoor temp.
R6 control (83, 84)

Page 23

Trends
Outdoor temp.
H1 Supply water
H1 Return water
...

Page 24

Alarms
Active alarms
Acknowledge all alarms
Alarm history
Reset alarm history
Alarm receivers
Routing schedule
Alarm signal

Page 27

System settings
Time
Date
Daylight saving
Language
SMS settings
Network settings
Display settings
Type info
Lock code

2 Inputs and outputs

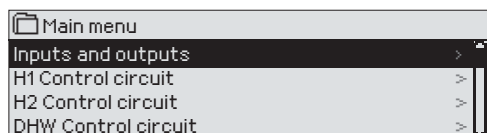

Inputs and outputs

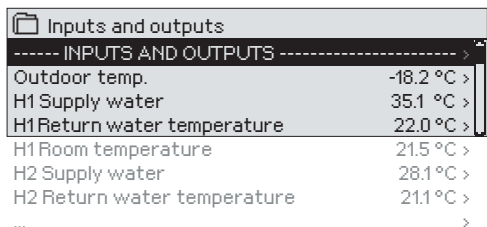

You can see the inputs and outputs of A203 which are configured in use. Configuration of the inputs and outputs is done in service menu (see p. 37-40). General measurements are temperature measurements which can be used for serial different purposes. The default names of the measurements can be changed according to use case.

If the sensor is not connected or is defective, the measurement value shown will be -50°C (cross sensor) or +130 °C (sensor circuit shorted). If a measurement is in manual mode, a hand image is shown in the beginning of the line.

- 1 Inputs and outputs are shown by the regulator in circuit-specific groups. First H1, then H2 and last DHW
- 2 Informational general measurements, which can be used for several purposes. Measurements can be named in the service menu. (Navigate: Service -> Connections and configuration).

Measurement	Range	Measurement information
Home/Away mode	Home/Away	Home-Away mode. By pressing OK you can change the status of the Home/Away mode. The mode can also be changed by Home/Away-switch or by text message "Home" or "Away" when a GSM-modem (optional) is available.
-----INPUTS-----		
Outdoor temp.	-50...+130 °C	Measured current outdoor temperature.
1 H1 /H2 Supply water	-50...+130 °C	Current temperature of the water entering the heating network.
H1 /H2 Return water temperature	-50...+130 °C	Current temperature of the water returning from the heating network.
H1 /H2 Room temperature	-50...+130 °C	Current room temperature.
DHW Supply water	-50...+130 °C	Current domestic hot water temperature.
DHW Circulation water temp.	-50...+130 °C	When there is no consumption, the measurement shows the temperature of DHW return water. During consumption, the measurement will show the mixed temperature of cold water and return water, in which case the measurement is used in so-called anticipation to improve the regulation result.
2 H1/H2 DH Return	-50...+130 °C	Temperature of return water after the district heat exchanger or other freely named temperature measurement.
2 DH Supply water temp.	-50...+130 °C	Temperature of water coming from the district heating plant.
2 DH Return water temp.	-50...+130 °C	Temperature of water returning to the district heating plant.
M10 (M11) Switch alarm mode	Off/On	Information of the alarm contact.
General compensation	0...100%	General compensation input value.
Measurement M11 (M12, M13)	-50...+130 °C	Freely nameable general measurement.
Pressure switch mode	Off/ On	When the pressure of the network lowers below the pressure alarm level, the state of the switch is changed to on and an alarm is activated.
Pressure measurement	0.... 16 bar	Pressure of the heating network.
P2.1 (P2.2, P3.1, P3.2) Pump	stop/run	Status of the pump. (Run information is displayed if M15, M16, DI1 or DI2 is selected as "Pump Indication").
DI 1 (DI 2) Water volume		The measured amount of water consumption (cumulative value).
DI 1 (DI2) Energy measurement		The measured amount of energy consumption (cumulative value).
Moisture sensor	wet/dry	Shows the state (wet/dry) of the moisture sensor.

Measurement	Range	Measurement information
----OUTPUTS----		
Actuator control	0....100 %	Current actuator 1 control
Actuator control 2	0....100 %	Current actuator 2 control. If series driving is in use, actuator 1 will first open the valve and the controller will then start up actuator 2.
P2.1 (2.2, P3.1, P3.2) Pump control	Off/On	Pump control status. The information is displayed if the pump control is selected and measurement selection in measurement channel M15, M16, DI1 or DI2 is "Pump alarm" or "Not in use". Information is not displayed if measurement selection is "Pump indication" (=run information).
R5 control (81,82)	Off/On	Relay control mode at the moment. By pressing the OK key, the control mode can be changed to automatic / manual. If the control is manual, an image of the palm will appear at the beginning of the line.
R6 control (83,84)	Off/On	Relay control mode at the moment. By pressing the OK key, the control mode can be changed to automatic / manual. If the control is manual, an image of the palm will appear at the beginning of the line.
Solenoid valve control	On/Off	When the moisture sensor detects the moisture, the valve is driven to closed position (On). If you know the service code and want to control the valve manually, press OK, enter a service code, select "Manual" and then control mode: Off (open) or On (close).

Key word:

INPUTS

OUTPUTS

HOME

AWAY

Inputs:

Outdoor temp. -18.2 °C /
H1 Supply water 35.1 °C / H1
Return water 22.0 °C /
H1 Room temperature 21.5 °C /

Outputs:

H1 = Actuator control = 25 % /
H2 Actuator control = 26 % /
DHW Actuator control = 52 %/
P2.1 Pump control = 0n

Home:

Home-Away-control = Home/

If a GSM modem is connected to the controller, you can read measurement information with a mobile phone. (If the device ID is in use, add the device ID in front of the key word, e.g., TC01 Inputs ,see more information p. 48)

Send a message: Inputs

The controller sends the current measurement information to your mobile phone.

Same way send a message: Outputs

You can also change Home/Away mode.

Send a message: **Home**. The controller sends a response message, which shows, that Home/Away -control is on Home-mode. Similarly you can send a message: **Away**.

3 Regulation of supply water in heating circuits

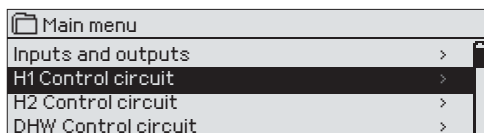

The A203 enables control of two different supply water circuits independently (H1 and H2).

Regulation of the temperature of supply water is controlled by the outside temperature. Use of room temperature measurements keeps room temperature more consistent.

3.1 Info

H1 (H2) Control circuit-> Info

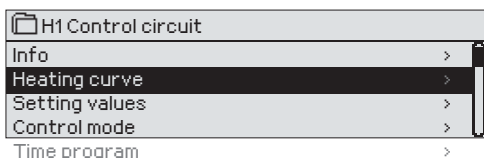

The info shows which factors are affecting currently the supply water temperature control. The starting point is the supply water temperature according to the outdoor temperature (according to the heating curve).

If a room sensor is connected to the controller, you can check which factors currently determine the room temperature setting value at the time of inspection.

In addition the info menu contains the measurement temperature data affecting to supply water control and information of control of actuators.

Factors effecting the supply water temp.	Explanation
--- SUPPLY WATER ---	
According to curve	Supply water temperature setting according to the curve at the current outdoor temperature.
Effect of parallel shift	Effect of parallel shift on the supply water temperature.
Effect of time program	Effect of weekly or exception schedule mode on the temperature of supply water. Near the end of the temperature reduction time, the pre-increase operation can increase the temperature of supply water.
Force control effect	Supply water has been forced permanently to the desired temperature reduction level (see Control mode selection).
Away -control effect	"Away" control for reduction of supply water temperature. The trigger can come from the Home/Away switch, the controller or be sent as a text message (see 42).
Outdoor temp. delay effect	The effect of the outdoor temperature delay on the supply water temperature.
Floor heat. anticipate	Effect of anticipation of floor heating on the temperature of supply water.
Effect of autumn drying	Effect of automatic autumn drying on the supply water temperature.
Return water compensation	Increase in supply water temperature due to return water compensation.
Heat exchanger DH Return comp. effect	Supply water increase caused by temperature compensation for return water from district heating exchanger.
Effect of room compensation	Effect of room compensation on the supply water.
Room comp. time adjustment	Additional correction for more precise room compensation based on realised regulation (effect of I-regulation).
General compensation effect	General compensation can be based for example on wind, solar or pressure measurements.
Bus compensation effect	The amount of required compensation is determined by an external device to the A203, for example from bus compensation to weather compensation.
Min limit effect	Supply water temperature increase due to the minimum limit.
Max limit effect	Supply water temperature drop due to the maximum limit.
Calculated supply water setting	Current supply water temperature determined by the controller.
Controller is stopped for summer	When the regulator is in summer function mode, the supply water information says "Controller is stopped for summer."
Controller is in manual control	Control circuit mode is set to "Manual control".

Factors effecting the room temperature	Explanation
---- ROOM TEMPERATURE -----	
Room temperature setting	Room temperature setting set by the user.
Time program effect on room temp.	Room temperature drop by weekly or exception schedule.
Away -control effect	Home/Away mode for reduction of room temperature. The trigger can come from the controller (see Inputs and outputs-> Home-Away-control), from the Home/Away switch or be sent as a text message.
Force control effect	Room temperature has been forced permanently to the desired reduction in room temperature (see Control mode selection, p.13).
Effect of autumn drying	Effect of automatic autumn drying on room temperature.
Calculated room temperature	Current room temperature setting determined by the controller.
---- MEASUREMENTS -----	
Supply water temperature	Current measured supply water temperature.
Outdoor temp.	The measured outdoor temperature. Outdoor temperature data is displayed if the delayed outdoor temperature is not used in supply water control.
Delayed outdoor temperature	If the heating mode is set to radiator heating, the delayed temperature measurement can be used in supply water control. Typically 2 hours delay time is used (time can be set in service menu). In supply water control the controller uses delayed measurement as an outdoor temperature.
Anticipated outdoor temperature	If the heating mode is set to floor heating, the anticipated temperature measurement can be used in supply water control. Typically 2 hours anticipation time is used (time can be set in service menu). In supply water control the controller takes into account the outdoor temperature change rate.
Room temperature	The measured room temperature or room temperature from the bus. The measurement is not necessarily taken into use in all control processes.
Delayed room temperature	The floating average of room temperature. The controller uses this value, when calculating the room compensation demand (the delay time of room temperature measurement is adjustable, default 0.5 hours).
Return water temperature	Presents measured return water temperature.
---- ACTUATOR CONTROL -----	
Actuator control	Current actuator control.
Actuator control 1 (2)	Current actuator 2 control. If serial-driving is in use, actuator 1 will first open the valve and the controller will then start up actuator 2.
Actuators control	50 % means that the valve 1 is totally open and the valve 2 is totally closed. 100% means that both valves are open.
---- PUMPS-----	
P2.1 (3.1) Pump	The state of the pump.
P2.2 (3.2) Pump	The state of the reserve pump/alternative pump.
P2.1 (3.1) Pump control	Control of the pump.
P2.2 (3.2) Pump control	Control of the reserve pump/alternative pump.
P2.1 (3.1) Run time	Running time for pump from the counter.
P2.2 (3.2) Run time	Running time for reserve/ alternative pump from the counter.
Pump in progress	Indicates which of the pumps is running in P2.1 or P2.2 (H1)/ P3.1 or P3.2 (H2 circuit).

Key words:

H1 INFO

H2 INFO

H1 info:

--- H1 SUPPLY WATER-----
 According to curve 35.1 °C/
 Away -control effect -6.0 °C/
 Calculated supply water
 setting = 29.1 °C.
 --- MEASUREMENTS -----
 Supply water = 35.2 °C
 Outdoor temp.= -10.7 °C
 --- ACTUATOR CONTROL-----
 Actuator control = 20 %

Send a message: H1 Info.

The controller sends a supply water info from the H1 heating circuit to your mobile phone that shows current supply water temperature at the present and the factors effecting supply water control.

The message also includes the measurements which are affecting the supply water control and the actuator control.

The message cannot be changed or sent back to the controller.

3.2 Heating curve

H1 (H2) Control circuit-> Heating curve

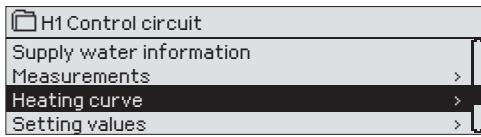

The supply water temperature for different outdoor temperatures is set with heating curve. With A203 the heating curve can be adjusted exactly to meet the needs of the facility from five temperature points.

Setting	Factory setting	Explanation
Heating curve -20 = 38 °C -10= 34 °C 0 = 28 °C +10=24 °C +20 = 18 °C Min.limit: 18 Max limit: 45		With 5-point curve you can change the curve to the outdoor temperature values -20°C and +20°C as well as to three other outdoor temperatures between -20°C and +20°C. To change the outdoor temperature point, press OK for a long period of time.
Min limit	18 °C	Minimum allowed supply water temperature. A higher minimum temperature is used in moist rooms and tiled rooms than in, e.g., rooms having a parquet floor to ensure a comfortable temperature and removal of moisture in the summer. The summer function can stop the pump and close the valve, which can cause the supply temperature to fall below the minimum limit. If necessary, increase the setting of "Summer function outdoor t. limit " (default 19 ° C, see page 13).
Max limit	45 °C	Maximum allowed supply water temperature. If, for example, the setting of the heating curve is incorrect, the maximum limit supply water rise too hot. Still if the building has temperature-sensitive structures, we recommend using a mechanical thermostat C01A installed in the supply water pipe (see page 50 for more information).

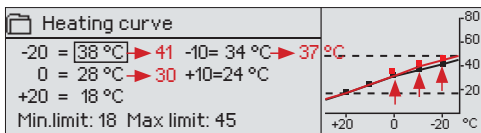

If room temperature drops, make the curve steeper. (Set higher values for supply water temperature at the outdoor temperatures -20 °C, -10 °C and 0 °C).

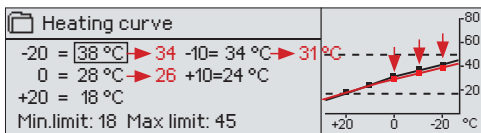

If room temperature rises, make the curve less steep. (Set lower values for supply water temperature at the outdoor temperatures -20 °C, -10 °C and 0 °C).

Note! Changes influence room temperature slowly. Wait at least 24 hours before readjusting the settings. Especially in buildings with floor heating, the delays in room temperature changes are quite long.

Typical heating curve settings:

5-point curve

1. Radiator heating, normal (default)

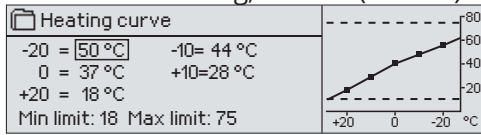

3. Floor heating, normal curve

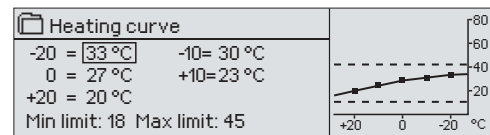

2. Radiator heating, steep curve

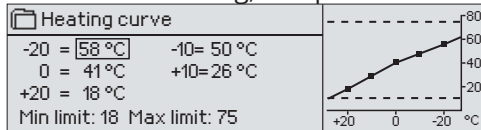

4. Floor heating, moist. rooms

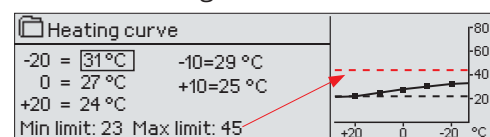

Settings of the heating curves of different heating modes

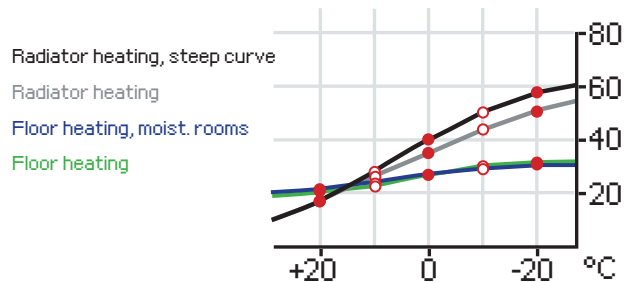

The presetted heating curves are typical average curves for the heating mode in question. The curve may need to be adjusted to suit your building. The setting should be done during the cold period and if the room compensation is in use, it should be switched off during the setting. The curve is appropriate when the room temperature is maintained constant although the outdoor temperature changes.

H1 Heating curve

H1 Heating curve
 Suppl.w. (-20) = 50 °C/
 Outd.t. 2 = -10 °C/
 Suppl.w. 2 = 44 °C/
 Outd.t. 3 = 0 °C/
 Suppl.w. 3 = 37 °C/
 Outd.t. 4 = 10 °C/
 Suppl.w. 4 = 28 °C/
 Suppl.w. (+20) = 18 °C

H1 Heating curve

H1 Heating curve
 Suppl.w. (-20) = 64 °C/
 Outd.t. 2 = -10 °C/
 Suppl.w. 2 = 47 °C/
 Outd.t. 3 = 0 °C/
 Suppl.w. 3 = 39 °C/
 Outd.t. 4 = 10 °C/
 Suppl.w. 4 = 23 °C/
 Suppl.w. (+20) = 20 °C
 Minimum limit = 18 °C/
 Maximum limit = 45 °C

H2 Heating curve

Send message: H1 Heating curve

The controller sends a message showing curve settings.

You can change the settings by replacing the setting value with a new one and sending a message back to the controller.

A203 will make the requested changes and send a new message showing the changes made.

3.3 Setting values

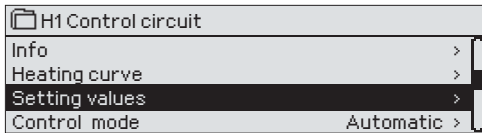

The regulator has two types of setting values: those that are always visible and those that can only be changed using a service code (see page 41).

Changing a setting:

- Choose the desired setting by turning the control knob.
- Press OK to go to the view where editing is possible. Change the setting.
- Press OK to accept the change.
- If you want to exit edit mode without making any changes, press ESC.

H1 (H2) Control circuit-> Setting values

Both circuits have the same circuit-specific setting values.

Setting	Factory setting	Range	Explanation
Room temperature setting	21.5	5... 50 °C	Basic room temperature setting for the controller set by the user. This setting value is not visible unless room compensation is in use. The room compensation can be taken in use from the "Room temperature settings" menu.
Summer function outdoor t. limit	19.0	10... 35 °C	Summer function outdoor temperature limit. When the measured or forecast outdoor temperature exceeds the outdoor temperature limit of the summer function, the valve will be closed and the circulation water pump will stop as selected. The summer function is switched off, when the temperature drops 0.5 °C under summer function outdoor temperature limit. In this case, the pump is switched on and the valve returns back to control mode.
Pump summer stop	In use	In use/ Not in use	If the controller is connected to control the pump, the pump can be stopped when the summer function is active.
Valve summer close	In use	In use/ Not in use	The setting value is used to select whether or not the valve is closed when the summer function is in use.
Autumn dry effect on supply water	4.0	0... 25 °C	The setting value defines how much the autumn dry function increases supply water temperature. If room temperature regulation is in use, the user sets how much the room temperature is increased.
Autumn dry effect on room temp.	1.0	0.0... 1.5 °C	
Room compensation settings			
Room compensation	In use	In use/ Not in use	With room compensation it's defined whether room temperature affects regulation of supply water. If the measured room temperature differs from its setting value, room compensation corrects the temperature of the supply water. Room compensation will not be performed if the room temperature measurement is alarming (measurement is less than 1.0 °C with an alarm delay of 10 min).
Room compensation ratio		0...7	Coefficient which is used in applying the difference between room measurement and the room setting value to the supply water setting value. For example, if room temperature in radiator heating is one degree below the setting value, supply water is raised by four degrees.
Radiator heating	4.0		
Floor heating	1.5		
Temperature drops			
Temperature drop		0... 40 °C	Temperature drop of supply water, which can start due to time programs or a Home/Away text message command or when selecting continuous temperature drop as the circuit's control mode. If room temperature measurement has been taken into use, the temperature drop is given directly as a room temperature drop.
Radiator heating	3.0		
Floor heating	1.5		
Home/Away control	H1: In use H2: Not in use	In use/ Not in use	The Home/Away control changes the temperature levels. If transmitter for general compensation is connected to controller, it's not possible to connect Home/Away switch. In this case Home/Away mode can be switched with SMS or from "Inputs and Outputs" menu.

Key words:

H1 Setting values

H2 Setting values

H1 Setting values:
 Room temperature = 21.5°C/
 Temperature drop = 3.0°C/

Send a message: H1 Settings.

The controller sends settings to your mobile phone. Editing the setting values: write the new setting in place of the old setting and send a message back to the controller. The controller sends back the setting as a confirmation.

3.4 Control mode

H1 (H2) Control circuit-> Control mode

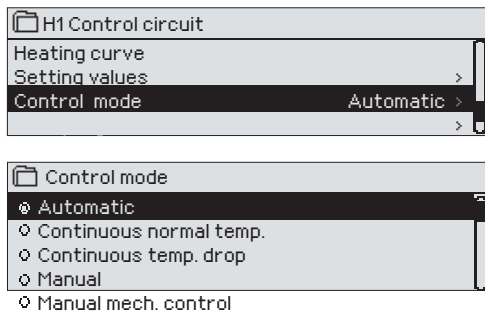

Automatic control is the mode that is used normally. You may change automatic control to manual control here, and drive the valve to the desired position. You can also force control to the desired temperature level. A continuous mode command by-passes possible scheduling programmes.

Control mode	Explanation
Automatic	A203 controls the supply water temperature automatically according to the heating demand and time programs.
Continuous normal temp.	Forced normal heating. All time programs are by-passed.
Continuous temp. drop	Forced temperature drop. All time programs are by-passed.w
Manual	<p>The controller runs the valve to manual position. The controller has the latest manual position in the memory. You can change the actuator manual position by changing the setting value.</p> <p>In manual mode the valve's position is changed with the setting value "H1 (H2) Manual mode position."</p>

Manual mechanical

Mechanical manual control option is taken into use in the controller. Connections and configuration -> H1 (H2) Actuator control -> Manual mech. control "Available".

If you want the voltage controlled actuators to be controlled by manual mechanical control, H1 actuator power supply must come from strip connecto 42 and H2 actuator power supply from strip connector 44. The controller switches off the power supply, when the control mode is manual mechanical control.

The valve position is set in the actuator when using mechanical manual control.

H1 CONTROL MODE

H1 Control mode:
 *Automatic/
 Continuous normal temp./
 Continuous temp. drop/
 Manual 0 %

H1 Control mode:
 Automatic/
 Continuous normal temp./
 Continuous temp. drop/
 *Manual(20 %)

H2 Control mode

Send a message: H1 Control mode

The controller sends a return message in which a * appears in front of the control mode in use. If you want to change the control mode, move the * in front of the desired control mode and send the message back to the controller. The controller will then send a return message showing that it has switched to the desired control mode.

3.5 Time programs

H1 (H2) Control circuit-> Time programs

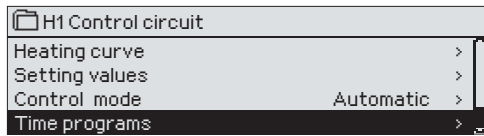

Weekly schedules, special days and exception schedules can be added to heating regulation in the A203. You can lower temperatures desired times by using these time programs.

3.5.1 Weekly schedule

H1 (H2) Control circuit-> Time programs -> Weekly schedule

Graph view

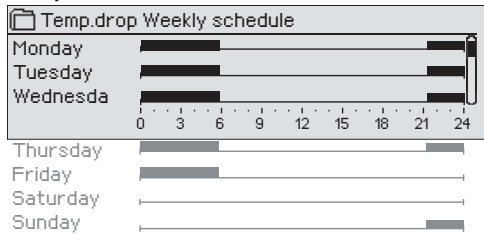

Weekly programmes have a general graph view as well as a edit view showing the exact time when the new state will be executed. In the graph view, exceptions to normal temperature of control are shown as bars.

Browsing a weekly schedule:

Turn the control knob to browse a weekly schedule. If you wish to see the exact switch times or you wish to change, delete or add switch times, press OK at any weekday.

Editing view

Time	Mode	M	T	W	T	F	S	S
21:00	Temp.drop	<input checked="" type="checkbox"/>	<input checked="" type="checkbox"/>	<input checked="" type="checkbox"/>	<input checked="" type="checkbox"/>	<input checked="" type="checkbox"/>	<input type="checkbox"/>	<input type="checkbox"/>
06:00	Normal temp.	<input checked="" type="checkbox"/>	<input checked="" type="checkbox"/>	<input checked="" type="checkbox"/>	<input checked="" type="checkbox"/>	<input checked="" type="checkbox"/>	<input type="checkbox"/>	<input type="checkbox"/>
00:00	Add new	<input type="checkbox"/>	<input type="checkbox"/>	<input type="checkbox"/>	<input type="checkbox"/>	<input type="checkbox"/>	<input type="checkbox"/>	<input type="checkbox"/>

In this example, you can see a weekly temperature drop program. Temperature drop is on from 10 pm to 6 am from Monday to Friday.

Adding a new switch time:

1. Press OK at the "Add new" row.
2. You can select the value you want to change using the control knob. By pressing OK you can change the value. Press ESC to return without changing the value.
3. Set the switch time (set hours and minutes separately). Press OK to accept.
4. Press OK and then turn the control knob to set the temperature level. Press OK to accept.
5. Press OK at each weekday you wish to choose.
6. Press OK at the end of the row to accept the new time program.
Note! Remember also to define when the control returns to automatic (=normal). Press Esc to exit.

Editing view

Time	Mode	M	T	W	T	F	S	S
06:00	Normal temp.	<input checked="" type="checkbox"/>	<input checked="" type="checkbox"/>	<input checked="" type="checkbox"/>	<input checked="" type="checkbox"/>	<input checked="" type="checkbox"/>	<input type="checkbox"/>	<input type="checkbox"/>
17:00	Temp. drop	<input checked="" type="checkbox"/>	<input checked="" type="checkbox"/>	<input checked="" type="checkbox"/>	<input checked="" type="checkbox"/>	<input checked="" type="checkbox"/>	<input type="checkbox"/>	<input type="checkbox"/>
00:00	Add new	<input type="checkbox"/>	<input type="checkbox"/>	<input type="checkbox"/>	<input type="checkbox"/>	<input type="checkbox"/>	<input type="checkbox"/>	<input type="checkbox"/>

Annotations: Set switch time (points to 17:00), Set state (=desired temp. level) (points to Temp. drop), Select day(s) (points to M-F), Accept (points to OK button).

Editing a weekly schedule:

1. Turn the control knob to move to the value you wish to change and press OK.
2. Turn the control knob to change the time and temperature. Press OK to accept.
3. Press the OK button to change the day of the week.
4. Press Esc to exit.

Time	Mode	M	T	W	T	F	S	S
21:00	Temp. drop	<input checked="" type="checkbox"/>	<input checked="" type="checkbox"/>	<input checked="" type="checkbox"/>	<input checked="" type="checkbox"/>	<input checked="" type="checkbox"/>	<input type="checkbox"/>	<input type="checkbox"/>
06:00	Delete switch time	<input checked="" type="checkbox"/>	<input checked="" type="checkbox"/>	<input checked="" type="checkbox"/>	<input checked="" type="checkbox"/>	<input checked="" type="checkbox"/>	<input type="checkbox"/>	<input type="checkbox"/>
00:00	Add new	<input type="checkbox"/>	<input type="checkbox"/>	<input type="checkbox"/>	<input type="checkbox"/>	<input type="checkbox"/>	<input type="checkbox"/>	<input type="checkbox"/>

Deleting a switch time:

1. Turn the control knob to move to the switch time you wish to delete and press OK.
2. Press OK at temperature level and select "Delete switch time".
3. Press OK at the end of the row.

Tip: With the pre increase function the controller automatically increases supply water temperature at the end of the reduction phase. Normal temperature has already been reached when the heating mode changes to normal heat.

3.5.2 Exception schedule

H1 (H2) Control circuit-> Time programs -> Exception schedule

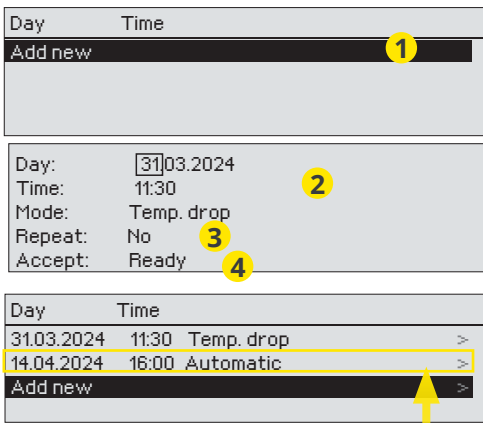

The picture shows an exception schedule. Heat reduction is on from 31 March 2024, 11:30 to 14 April 2024, 16:00

NOTE! Remember to also set the end time for the exception schedule! When you set the date and time, the mode will change to "Automatic". In this case, the control returns back to the weekly schedule. If you selected that the start time "Repeats every month or every year", you have to do same selection to the end time.

You can easily make changes that differ from normal routine use by using the exception schedule. The date, time and mode to which heating will be changed in the period in question are entered in the exception schedule. To switch from an exception schedule to weekly schedule mode, select automatic mode.

Adding a new switch time:

1. Navigate to "Exception schedule" and press OK. The display will read "Add new." Press OK
2. Press OK and set the start date for the program, then the time and mode. You can select from the following:
 - one day schedule from the weekly schedule (Monday - Sunday)
 - a special day from the special day program (SD1 - SD7)
 - one of the following heating levels: "temperature drop," or "normal"
 - "automatic."
3. Select, if the exception schedule repeats or not. If you select repeat, it can be repeated every month same time or every year same time.
4. Accept the exception schedule you created by pressing "Ready."

Deleting a switch time from an exception schedule:

1. Navigate to the row with the activation time you want to delete.
2. Select "Delete switch time."
3. Accept the deletion by pressing "Ready."

3.5.3 Special days

H1 (H2) Control circuit-> Time programs -> Special days

Graph

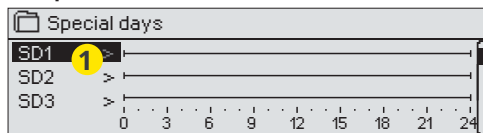

Editing view

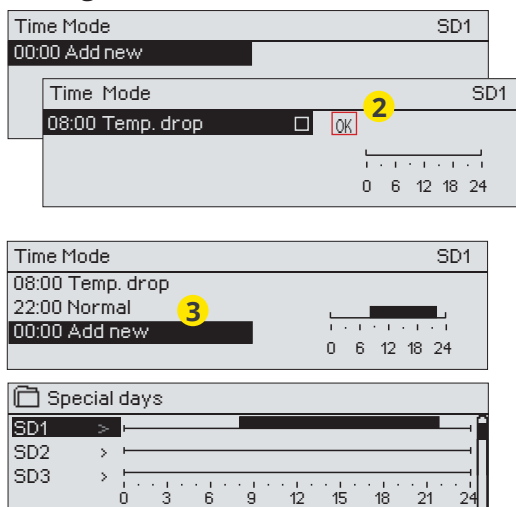

You can enter special day programs as exceptions to normal weekly schedule. You can designate a maximum of 7 special day programs (SD). A special day program is typically created for each holiday. When the special day program will be applied it is set in the exception schedule.

Adding a new switch time:

1. Navigate to "Special days" and press OK. Select an unused special day and press OK.
2. Place the cursor on "Add new" and press OK. Set the time for the program (hours and minutes are set separately). Select the mode to be switched to at the time specified. Accept the program by pressing OK when the cursor is on OK.
3. Navigate to the "Add new" row. Set the time when the mode will change from temperature drop mode back to normal temperature. Accept the program by pressing OK. You can set several different periods of temperature drop for the same special day.

Deleting a switch time from special day program:

1. Navigate to the row with the switch time you want to delete.
2. Select "Delete switch time."
3. Accept the deletion by pressing "Ready."

3.5.4 Temp. level according to time program

Controller shows, what is the current heat level according to the time program.

4 Domestic hot water control

Main menu	
H1 Control circuit	>
H2 Control circuit	>
DHW Control circuit	>
Alarms	>

The A203 keeps the temperature of domestic hot water at the designated value. Because of the danger of bacteria, it is recommended that the domestic hot water temperature is not permanently set below +55 °C.

DHW Control circuit	
Info	>
Setting values	>
Control mode	Automatic >
Trend display	>

Info

DHW Info	
Domestic hot water setting values	58.0 °C>
Supply water temperature	54.6 °C>
Circulation water temp.	53.2 °C>
----- ACTUATOR CONTROL -----	
Actuator control	75 %

Info-menu shows the domestic hot water settings, the measurements and actuator control related to the domestic hot water.

Setting values

Setting name	Factory setting	Range	Explanation
Domestic hot water setting value	58.0 °C	20...90 °C	Domestic hot water temperature setting.
Anticipation control	In use	In use/ Not in use	Anticipation speeds up regulation when water consumption changes by using measurement information from the circulation water sensor.
DHW reduction/incr. Time program	Not in use	Not in use/ In use	The amount of the temperature reduction of DHW in time programs.
DHW reduction amount	10.0 °C	0...30 °C	The amount of the temperature reduction of DHW in time programs.
DHW increment amount	10.0 °C	0...30 °C	The amount of the increment of DHW in time programs.

Control mode

Control mode	Explanation
<div style="border: 1px solid black; padding: 5px;"> <ul style="list-style-type: none"> Control mode ⊙ Automatic ⊙ Manual ⊙ Manual mechanical </div>	<p>Automatic mode is normally used in regulating domestic hot water. Here you can switch from automatic to manual mode and move the vent into the desired position. You can use manual mode for example when a sensor malfunctions.</p>
Automatic	A203 maintains the temperature of domestic hot water at the setting value set by the user.
Manual	<p>The desired position of the valve is set with the setting value "Actuator Manual position."</p> <div style="border: 1px solid black; padding: 5px; margin-top: 10px;"> <ul style="list-style-type: none"> DHW Domestic hot water control Info > Setting values > Control mode Manual > Actuator manual position 20 % > </div>
Manual mechanical	<p>Manual mechanical control option must be taken into use. (Connections and configuration -> DHW Actuator control -> Manual mech. control "Available"). If you want the voltage controlled actuators to be controlled by manual mechanical control, DHW actuator power supply must come from strip connector 45. The controller switches off the power supply, when the control mode is set manual mechanical control.</p> <p>The valve position is set in the actuator when using mechanical manual control</p>

Trend display

<div style="border: 1px solid black; padding: 5px;"> <ul style="list-style-type: none"> Trend display Supply water temperaure > Circulation water temp. > Actuator control > </div>	<p>You can read the real-time trends of the temperatures of supply water and circulation water. Also the real-time trend of actuator control in domestic hot water circuit can be read. The sampling interval is 1 s.</p>
--	---

4.1 Time programs

DHW Control circuit-> Time programs

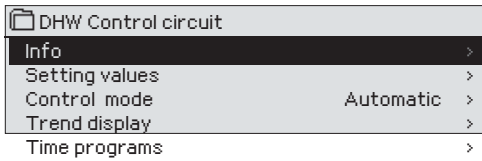

You can change the supply water temperature with time program. You can define in Supply water settings how much the time program deflects the temperature from the normal supply water setting.

Weekly schedule

DHW Domestic hot water control -> Time programs -> DHW recuction/incr. Weekly schedule

Graph view

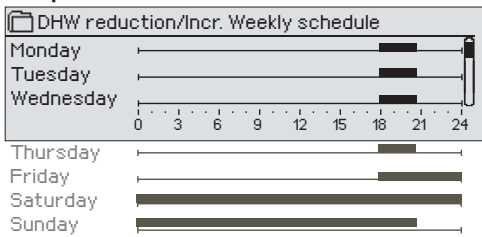

Weekly programmes have a standard graph view as well as a change view showing the exact time when the new mode command will be executed. In the graph view, exceptions to normal temperature reductions are shown as bars.

Browsing a weekly program:

Turn the control knob to browse a weekly program. If you wish to see the exact switch times or you wish to change, delete or add switch times, press OK at any weekday.

Editing view

Time Mode	M	T	W	T	F	S	S
18:00 Increase ON	<input checked="" type="checkbox"/>	<input checked="" type="checkbox"/>	<input checked="" type="checkbox"/>	<input checked="" type="checkbox"/>	<input type="checkbox"/>	<input type="checkbox"/>	<input type="checkbox"/>
21:00 Normal	<input checked="" type="checkbox"/>	<input checked="" type="checkbox"/>	<input checked="" type="checkbox"/>	<input type="checkbox"/>	<input type="checkbox"/>	<input type="checkbox"/>	<input checked="" type="checkbox"/>
00:00 Add new	<input type="checkbox"/>	<input type="checkbox"/>	<input type="checkbox"/>	<input type="checkbox"/>	<input type="checkbox"/>	<input type="checkbox"/>	<input type="checkbox"/>

In the example the domestic hot water increase is on from Monday to Thursday 18.00-21.00 and at the weekend from Friday 18:00 to Sunday 21:00.

Adding a new switch time:

1. Press OK at the "Add new" row.
2. Set the switch time (set hours and minutes separately). Press OK to accept.
3. Press OK and then turn the control knob to set the temperature level (Drop ON/ Increase ON/ normal). Press OK to accept.
4. Press OK at each weekday you wish to choose.
5. Press OK at the end of the row to accept the new time program.

Note! Also remember to define when the control returns to automatic (=normal). Press Esc to exit.

Note! Remember also to make the end section to the controls, i.e. set the time of the return to the "Normal" time, i.e. to the normal domestic hot water control. Press ESC to exit the programming mode.

Exception schedule

DHW Domestic hot water control -> Time programs -> Exception schedule

Day	Time
Add new	>

Day: 17.06.2024
 Time: 11:30
 Mode: Increase ON
 Repeat: No
 Accept: Ready

Day	Time	Mode
17.06.2024	11:30	Increase ON
25.06.2024	16:00	Automatic
Add new		>

The picture shows an exception schedule program. Domestic hot water increase is on from 17 June 2024, 11:30 to 25 June 2024, 16:00

NOTE! Remember to also set the end time for the exception schedule program! When you set the date and time, the mode will change to "Automatic". In this case, the control returns back to the weekly schedule. If you selected that the start time "Repeats every month or every year", you have to do same selection to the end time.

You can easily make changes that differ from normal routine use by using the exception schedule. The date, time and mode to which domestic hot water temperature will be changed in the period in question are entered in the exception schedule. To switch from an exception schedule to weekly schedule mode, select automatic mode.

Adding a new activation time:

1. Navigate to "Exception schedule" and press OK. The display will read "Add new." Press OK
2. Press OK and set the start date for the program, then the time and mode. You can select from the following:
 - one day schedule from the weekly schedule (Monday - Sunday)
 - a special day from the special day program (SD1 - SD7)
 - one of the following heating levels: "Drop ON", "Increase ON," or "Normal"
 - "automatic."
3. Select, if the exception schedule repeats or not. If you select repeat, it can be repeated every month same time or every year same time.
4. Accept the exception schedule you created by pressing "Ready."

Deleting an activation time from an exception schedule:

1. Navigate to the row with the activation time you want to delete.
2. Select "Delete switch time."
3. Accept the deletion by pressing "Ready."

Special days

DHW Domestic hot water control -> Time programs -> Special days

Graph

Special days
SD1
SD2
SD3

Editing view

Time Mode SD1
 00:00 Add new

Time Mode SD1
 08:00 Increase ON

OK

You can enter special day programs as exceptions to normal weekly schedule. You can designate a maximum of 7 special day programs (SD). A special day program is typically created for each holiday. When the special day program will be applied it is set in the exception schedule.

Adding a new activation time:

1. Navigate to "Special days" and press OK. Select an unused special day and press OK.
2. Place the cursor on "Add new" and press OK. Set the time for the program (hours and minutes are set separately). Select the mode to be switched to at the time specified. Accept the program by pressing OK when the cursor is on OK.
3. Navigate to the "Add new" row. Set the time when the mode will change from temperature increase/ drop mode back to normal temperature. Accept the program by pressing OK. You can set several different periods of temperature drop for the same special day.

Temp. level according to time program

Controller shows, what is the desired heat level, at the moment according to the time program. You can also force control to the desired temperature level by pressing OK and selecting manual control (enter the service code).

Present value	Explanation
Normal	Domestic hot water setting value is used in domestic hot water control.
Increase ON	The setting value is used in domestic hot water control, which is "Domestic hot water setting value" + "DHW increment amount".
Drop ON	The setting value is used in domestic hot water control, which is "Domestic hot water setting value" - "DHW reduction amount".

5 Relay 5 and relay 6 control

Control mode
Not in use
Heating thermostat (R5)
Cooling thermostat (R5)
Defrost thermostat (R5)
Heat. therm.& time ctrl (R5)
Cool. therm.& time ctrl (R5)
Defr. therm.& time ctrl (R5)
Time control (R5)

The relay controls can be taken into use in service menu (see p.39).

The relays are time- and/or temperature controlled. You can select, if the relay control R5 is outdoor temperature controlled or if it is controlled according to temperature measurement 10. The relay control R6 can be either outdoor temperature controlled or controlled according to the measurement 11. The display shows the measurement data of the selected temperature. If the sensor fault activates, the relay control switches off.

Relay 5 control
Function Heating thermostat (R5)
Setting value 5.0 °C >
Outdoor temperature 10.2 °C
R5 Control I (81,82) Off >

Heating thermostat: When the temperature drops to the setting value, the relay goes to on position. The relay goes to off-position when the temperature has risen equal to hysteresis amount (default 1.0 °C) above the setting value. If you want to edit the hysteresis setting value, navigate to the "Maintenance" -> "Connections and configuration".

Relay 5 control
Function Cooling thermostat (R5)
Setting value 21.5 °C >
Outdoor temperature 10.2 °C
R5 Control I (81,82) Off >

Cooling thermostat: When the temperature rises to the setting value, the relay goes to on position. When the temperature drops equal to the hysteresis amount (default 1.0 °C) below the setting value, the relay goes to off.

Relay 6 control
Function Defrost thermostat (R6)
Temperature limit 1 5.0 °C >
Temperature limit 2 -5.0 °C >
Outdoor temperature 10.2 °C
R6 Control I (83,84) Off >

Defrosting thermostat: When the temperature is between Temperature Limit 1 and 2, the relay goes ON. The relay goes Off when the measured temperature drops -0.5 °C below temperature limit 2 or rise 0.5 °C above temperature limit 1. The setting range for both temperature limits is -30 ... + 80 °C.

Relay 5 control

Function Heat therm. & time ctrl (R5)

Setting value 5.0 °C >

Time program >

Outdoor temperature 10.2°C

R5 Control I (81,82) Off >

Relay 5 control

Function Cool. therm.& time ctrl (R5)

Setting value 21.5°C >

Time program >

Outdoor temperature 10.2°C

R5 Control I (81,82) Off >

Relay 6 control

Function Defr. therm.& time ctrl (R6)

Temperature limit 1 5.0°C >

Temperature limit 2 -5.0°C >

Time program >

Outdoor temperature 10.2°C

R6 Control I (83,84) Off >

Relay 5 control

Function Time program (R5)

Time program >

Outdoor temperature 10.2°C

R5 Control I (81,82) Off >

Time Mode M T W T F S S

21:00 On

06:00 Off

00:00 Add new

Time program

Monday

Tuesday

Wednesday

Thursday

Friday

Saturday

Sunday

0 3 6 9 12 15 18 21 24

Heating thermostat and time control: The relay is controlled according to the time program and the temperature. The relay is on when the temperature is below the setting value and the time program allows the heating to go on. After the temperature has risen equal to the hysteresis amount above (default 1.0 °C) the setting value, the relay is off.

Cooling thermostat and time control: The relay is controlled according to the time program and the temperature. The relay is on, when the temperature rises to the setting value and the time program allows the cooling to go on. After the temperature has dropped equal to the hysteresis amount (default 1.0 °C) below the setting value, the relay is off.

Defrosting thermostat and time control: The relay is controlled according to the time program and the temperature. When the temperature is between Temperature Limit 1 and 2, the relay goes ON. The relay goes Off when the measured temperature drops -0.5 °C below temperature limit 2 or rise 0.5 °C above temperature limit 1. The setting range for both temperature limits is -30 ... + 80 °C.

Time control: The relay is controlled according to the time schedule. Adding a new switch time:

1. Press OK at the "Add new" row.
2. You can select the value you want to change using the control knob. By pressing OK you can change the value. Press ESC to return without changing the value.
3. Set the switch time (set hours and minutes separately). Press OK to accept.
4. Press OK and then turn the control knob to set the status of the relay. Press OK to accept.
5. Press OK at each weekday you wish to choose.
6. Press Esc to exit.

Relay control

Setting	Factory setting	Range	Explanation
Setting	21.0	-50.0...100.0	The relay 1 control is based on outdoor temperature or according to measurement 10. Relay 2 is controlled either according to the outdoor temperature or the measurement 11. These selections are done in controller configuration.
R5 control (81, 82) R6 control (83, 84)	auto- matic	automatic/ manual	The active control mode is shown in the display. You can change the control mode from automatic to manual. A hand image appears to the display on the line R5(6) if the control mode is manual.
Temperature limit 1 Temperature limit2	5.0 -5.0	-30...80 °C	The setting values of defrosting: Defrosting is on, when the temperature controlling the relay is between the Temperature limits 1 and 2 (and the time program allows the defrosting). The defrosting goes Off when the measured temperature drops -0.5 °C below temperature limit 2 or rise 0.5 °C above temperature limit 1.
Time program	-	On/Off	You can create a time program for relay control.

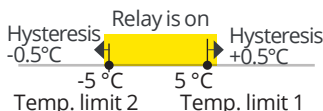

Time Mode M T W T F S S

21:00 On

06:00 Off

00:00 Add new

6 Trends

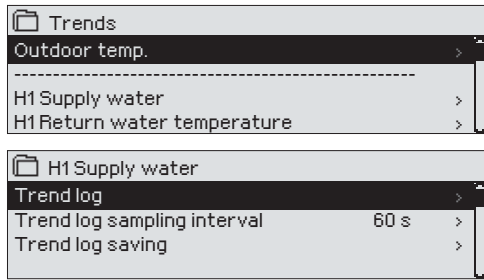

A203 saves automatically trend data from measurements.

When you press OK on the measurement in Trend menu you can review the trend log and change the sampling interval.

Setting	Factory setting	Range	Information about setting
Trend log			<p>The trend log is not shown in real time, i.e. the view is not updated in real time. The logged value from the time indicated by the cursor (hairline) is shown in the square brackets.</p> <p>The time between the brackets indicates the amount of the trend data in the current view (e.g. 7 hours). When OK button is pressed the more detailed trend view will be opened (e.g. 44 min). Browse the logged trend by turning the control knob.</p>
Trend log sampling interval	60 s	1 ... 600	<p>A different sampling interval can be set for different measurements. The memory can store 10,000 measurement samples. For example, if the sample interval is 60 seconds, the trend buffer will contain measurement information for one week. If the sampling interval is 1 seconds the buffer will contain measurement history approximately 2.7 hours.</p>

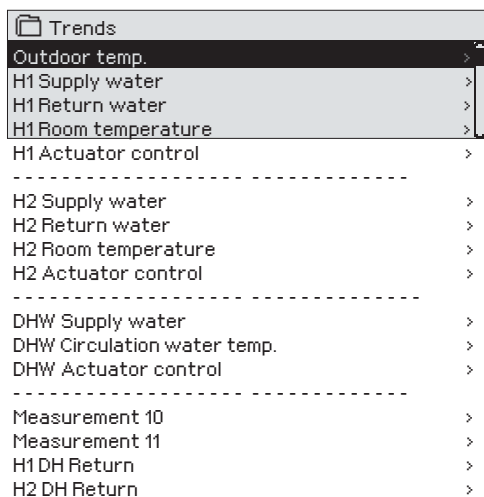

Sampling interval		
Mesasurement	Factory setting	Range
Outdoor temperature	60 s	60 ... 3600 s
H1/ H2 Supply water	60 s	1 ... 600 s
H1/ H2 Return water	60 s	1 ... 600 s
H1/ H2 Room temperature	60 s	1 ... 600 s
DHW Supply water	60 s	1 ... 600 s
DHW Circulation water	60 s	1 ... 600 s
H1 Actuator control	60 s	1 ... 600 s
H2 Actuator control	60 s	1 ... 600 s
DHW Actuator control	10 s	1 ... 600 s

7 Alarms

Acknowledging alarms: press OK and the alarm sound will mute. If the reason for the alarm is still present, the exclamation point in the top right will continue to blink.

 H1 supply water deviation alarm
 PR 1 GROUP 1 A203.G1010,TE41.DA1
 H1 Supply water temp. =10.2 °C
 Received: 08.02.2023 02:27
 Press OK to acknowledge the alarm



An alarm can activate in for a number of different reasons. Information about the activated alarm is shown on the display. Also a continuous alarm signal is given.

If the controller has a number of unacknowledged alarms and you acknowledge the last one, the one before it will appear on the display. When all active alarms have been acknowledged, the alarm window closes and the alarm sound goes off.

Alarm signal can be muted by pressing Esc key. **It should be noted that the alarms remain unacknowledged. You can find both active alarms and Alarm history in the Alarm menu.**

If the sensor is defective, the regulator's display will show the measurement reading -50 °C (cable of the sensor is broken) or 130 °C (sensor short circuited).

The disabling of alarms can be activated when configuring the controller. If the alarms are disabled, the next symbol is shown in the main display. The disabling is taken out of use in service mode -> Alarm settings -> Alarms: Disabled/Enabled.

Sensor error alarm (SE)				Delay areas: 0...600 s			
Terminal block	Sensor	Alarm text	Operation when a sensor is defective	Entry delay	Exit delay	Alarm group	Alarm priority
1	TMO	M1: Sensor fault Outdoor temperature	The control system uses the value of the outdoor temp. at -5 ° C.	20 s	1 s	2	2
2	TMW/TMS	M2: Sensor fault H1 Supply water	Valve remains in the position it was in before the sensor defect	20 s	1 s	1	1
3	TMW/TMS	M3: Sensor fault H1 Return water	Return water control is disabled.	20 s	1 s	2	2
4	TMR TMW/ TMS	Sensor fault M 4 Sensor fault M 4	Room control is taken out of use Informational measurement (H1 DH Return)	10 s 10 s	1 s	2 2	2 2
5	TMW/TMS	Sensor fault H2 Supply water	Valve remains in the position it was in before the sensor defect.	20 s	1 s	1	1
6	TMW/TMS	Sensor fault H2 Return water	Return water regulation is taken out of use	20 s	1 s	2	2
7	TMR TMW/ TMS	Sensor fault MI 7 Sensor fault M 7	Room control is disabled Informational meas. (H2 DH Return)	10 s 10 s	1 s	2 2	2 2
8	TMW/TMS	M8: Sensor fault DHW Supply water	Valve is closed.	5 s	1 s	1	1
9	TMW/TMS	M9: Sensor error DHW circulation water	Does not affect regulation	20 s	1 s	2	2
10	TMW/TMS	Sensor fault M 10	Informational measurement (DH Supply)	10 s	1 s	2	2
11	TMW/TMS	Sensor fault M 11	Informational measurement (DH Return)	10 s	1 s	2	2
12	TMW/TMS	Sensor fault M 12	Informational measurement	10 s	1 s	2	2
13	TMW/TMS	Sensor fault M 13	Informational measurement	10 s	1 s	2	2

Alarm	Entry delay	Exit delay	Alarm group	Alarm priority
Outdoor temperature from bus alarm	300s	1 s	2	2
P1 Pump alarm/ Alarm	5 s	1 s	1	1
P2 Pump alarm	5 s	1 s	1	1
P3 Pump alarm	10 s	1 s	1	1
Pressure switch alarm (M12/ M13)	30 s	1 s	1	1
Pressure alarm (M12/M13)	60 s	1 s	1	1
Switch alarm (M10 /M11)	30 s	1 s	1	1

Alarm	Entry delay	Exit delay	Alarm group	Alarm priority
Room temperature H1/H2	600s	5 s	2	2
H1/ H2 Freezing risk	5 min*)	5 s	1	1
H1/H2 Supply water deviation alarm	60 min*)	5 s	1	1
H1 /H2 H2 Overheat alarm	5 min*)	5 s	1	1
DHW overheating alarm	10 min*)	2 s	1	1
DHW low limit alarm	10 min*)	2 s	1	1
Free measurement (M 10/ M11)	60 s*)	5 s	1	1
Moisture sensor	5 s	1 s	1	1

Active alarms

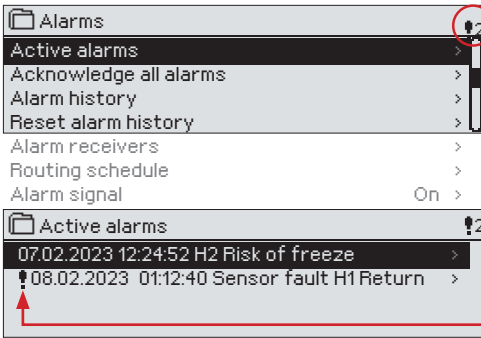

In the alarm menu of A203 device, you can check the active alarms and what alarms have been active. The number of active alarms will be shown in the right corner of the main view.

Every active alarm is shown in a separate row, where you can see when the alarm has become active. Press OK to get more information about the alarm.

An exclamation mark in front of the date shows that the alarm has not been acknowledged.

The reason for the alarm is shown in the heading.

You can also see, what is the alarm priority (1 = Emergency, 2=Danger, 3=Fault, 4= Service, 5=Info) and what alarm group it belongs to (Group 1 has urgent alarms and group 2 malfunction alarms).

Source of the alarm.

Time the alarm was received

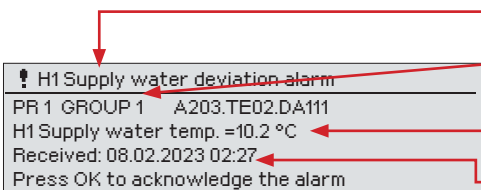

ACTIVE ALARMS

Send message: Active alarms

The regulator sends a message showing all active alarms. Message is informational.

Acknowledge all alarms

You can acknowledge all alarms by pressing OK.

Alarm history

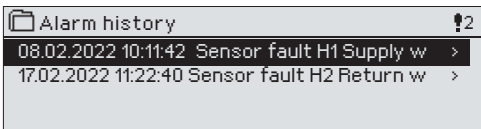

The reason, source and inactivation time (08.02.2022 10:11:42) is shown for every alarm in alarm history. The last 10 alarms can be seen in inactive alarms.

ALARM HISTORY

Send message: Alarm history

The controller sends a message showing the last 10 alarms. Message is informational.

Reset alarm history

A203 requests confirmation before deleting alarm history.

Alarm receivers

Alarm receivers

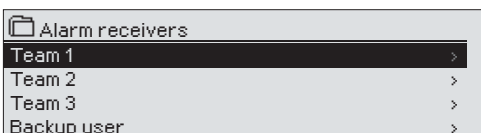

A GSM modem can be connected to the A203 for alarm sending a text message to the alarm team. The alarms are sent to correct team according to alarm routing schedule. When alarm is activated, the controller sends alarm messages automatically to phone numbers defined in team. If the alarm isn't acknowledged within 5 minutes, the alarm message will be re-sent to same recipients and also to backup user team. The A203 send max. 100 text messages within one day (a single alarm can contain several text messages).

Entering the telephone numbers:

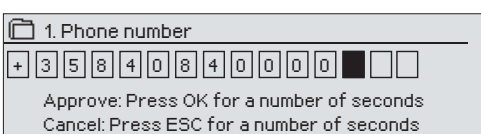

1. Turn the control knob. Press OK to accept a number/sign.
2. Press OK to move to the next square. Press Esc to return to the previous square. OK
3. Press OK for a number of seconds to accept the number. Press Esc for a number of seconds to cancel



Routing schedule

Alarms > Routing schedule

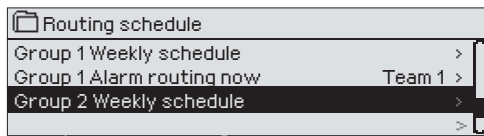

Graph

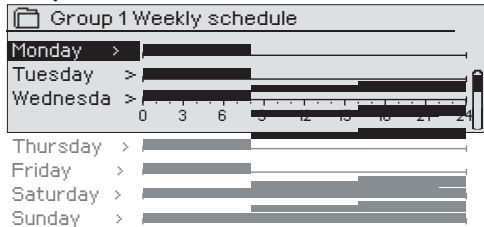

This example shows that group 1 alarms are always forwarded. During business hours (Monday - Friday 8:00 a.m. - 4:00 p.m.) alarms are forwarded to different teams than during evenings and weekends. More detailed information is shown in the "Editing view".

Editing view

Time	Mode	M	T	W	T	F	S	S
08:00	Team 1	<input checked="" type="checkbox"/>	<input checked="" type="checkbox"/>	<input checked="" type="checkbox"/>	<input checked="" type="checkbox"/>	<input checked="" type="checkbox"/>	<input type="checkbox"/>	<input type="checkbox"/>
16:00	Team 2	<input checked="" type="checkbox"/>	<input checked="" type="checkbox"/>	<input checked="" type="checkbox"/>	<input checked="" type="checkbox"/>	<input type="checkbox"/>	<input type="checkbox"/>	<input type="checkbox"/>
00:00	Add new	<input type="checkbox"/>	<input type="checkbox"/>	<input type="checkbox"/>	<input type="checkbox"/>	<input type="checkbox"/>	<input type="checkbox"/>	<input type="checkbox"/>

A203 default alarm groups are:

- Group 1: Urgent alarm that should always be immediately routed.
- Group 2: Malfunction alarms that can be routed during business hours.

You can see where alarms are currently being routed from the routing schedule menu. You can also set up a routing schedule for each alarm group.

You can create a weekly schedule for each alarm group. Weekly schedules have a general graphic view and an editing view, where you can see to which alarm team each alarm is sent at different times. In the graph, alarm teams are distinguished from each other by the bars with different thickness.

Turn the control knob to browse a weekly schedule. If you wish to see the exact switch times and names of alarm teams, or if you wish to edit, remove or add switch times, press OK at any weekday.

Browsing a weekly schedule:

An editing view opens, and it shows all the switch times and also to which alarm teams alarms are routed at these times on the chosen days.

1. Set switch time

2. Set alarm team

3. Select day(s)

Time	Mode	M	T	W	T	F	S	S
08:00	Team 1	<input checked="" type="checkbox"/>	<input checked="" type="checkbox"/>	<input checked="" type="checkbox"/>	<input checked="" type="checkbox"/>	<input checked="" type="checkbox"/>	<input type="checkbox"/>	<input type="checkbox"/>
16:00	Team 2	<input checked="" type="checkbox"/>	<input checked="" type="checkbox"/>	<input checked="" type="checkbox"/>	<input checked="" type="checkbox"/>	<input type="checkbox"/>	<input type="checkbox"/>	<input type="checkbox"/>
00:00	Add new	<input type="checkbox"/>	<input type="checkbox"/>	<input type="checkbox"/>	<input type="checkbox"/>	<input type="checkbox"/>	<input type="checkbox"/>	<input type="checkbox"/>

Adding a new switch time:

1. Press OK at the "Add new" row.
2. Press OK. Set the switch time for alarm routing (set hours and minutes separately) and press OK.
3. Press OK and then turn the control knob to set the alarm team or the "No routing" option. (No routing option means that alarms will not be sent.) Accept by pressing OK.
4. Press OK at desired weekdays you wish to choose.
5. Press OK at the end of the row to accept the created schedule.
6. Press Esc to exit.

Time	Mode	M	T	W	T	F	S	S
08:00	Team 1	<input checked="" type="checkbox"/>	<input checked="" type="checkbox"/>	<input checked="" type="checkbox"/>	<input checked="" type="checkbox"/>	<input checked="" type="checkbox"/>	<input type="checkbox"/>	<input type="checkbox"/>
16:00	No routing	<input checked="" type="checkbox"/>	<input checked="" type="checkbox"/>	<input checked="" type="checkbox"/>	<input checked="" type="checkbox"/>	<input type="checkbox"/>	<input type="checkbox"/>	<input type="checkbox"/>
00:00	Add new	<input type="checkbox"/>	<input type="checkbox"/>	<input type="checkbox"/>	<input type="checkbox"/>	<input type="checkbox"/>	<input type="checkbox"/>	<input type="checkbox"/>

Editing a weekly schedule:

1. Turn the control knob to navigate to the value you wish to change and press OK.
2. Turn the control knob to make the time and alarm team changes. Press OK to accept.
3. Press the OK button to change the day of the week.
4. Press Esc to exit.

Time	Mode	M	T	W	T	F	S	S
08:00	Team 1	<input type="checkbox"/>	<input type="checkbox"/>	<input type="checkbox"/>	<input type="checkbox"/>	<input checked="" type="checkbox"/>	<input checked="" type="checkbox"/>	<input type="checkbox"/>
21:00	Delete switch time	<input type="checkbox"/>	<input type="checkbox"/>	<input type="checkbox"/>	<input type="checkbox"/>	<input checked="" type="checkbox"/>	<input checked="" type="checkbox"/>	<input type="checkbox"/>
00:00	Add new	<input type="checkbox"/>	<input type="checkbox"/>	<input type="checkbox"/>	<input type="checkbox"/>	<input type="checkbox"/>	<input type="checkbox"/>	<input type="checkbox"/>

Deleting a switch time:

1. Turn the control knob to navigate to the switch time you wish to delete and press OK.
2. Press OK at the alarm team and select "Delete switch time"
3. Press OK at the end of the row.
4. To exit edit mode, press ESC.

Alarms are routed according to the routing schedule. You can acknowledge an alarm by forwarding the same message to the A203.

Alarm signal



You can take the alarm signal off, if you want.

On: Information about the activated alarm is shown on the display. Also a continuous alarm signal is given. If the controller has a number of unacknowledged alarms and you acknowledge the last one, the one before it will appear on the display. When all active alarms have been acknowledged, the alarm window closes and the alarm sound goes off.

Off: The controller displays information on activating the alarm, but the controller does not include an alarm signal.

8 System settings

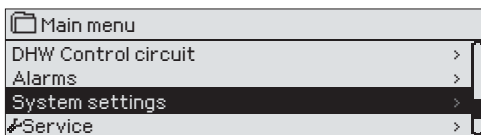

System settings include date and time, language, SMS and network settings, display settings and device type information.

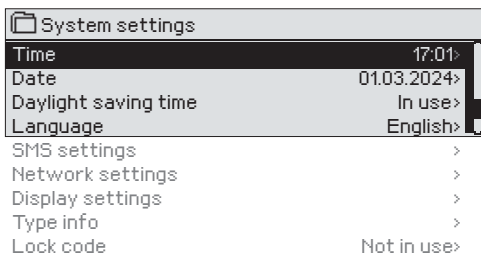

8.1 Setting date, time and language

System settings > Time

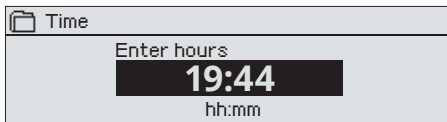

It is important that date and time are correct. The date and time are used e. g. in time programs as well as alarm indication and routing. The A203 clock takes daylight savings and leap years into account automatically. The clock has a backup for power outages lasting about two days.

1. Set hours and press OK to accept.
2. Set minutes and press OK to accept.
3. To exit without saving and changes press Esc.

System settings > Date

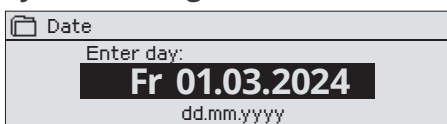

1. Set day and press OK to accept (name of weekday is updated automatically).
2. Set month and press OK to accept.
3. Set year and press OK to accept.
4. To exit without saving and changes press Esc.

System settings > Daylight saving time

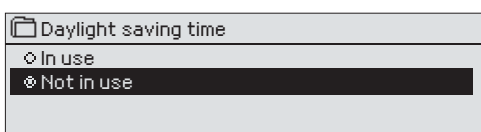

The controller will automatically be switched to to daylight saving time and to standard time, if the selection "In use" is made.

System settings > Language

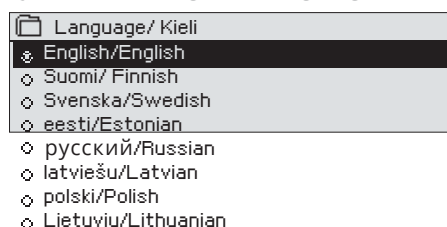

The language of the user interface can be change here.

8.2 Text message (SMS) settings and take the GSM modem into use

System settings > SMS settings

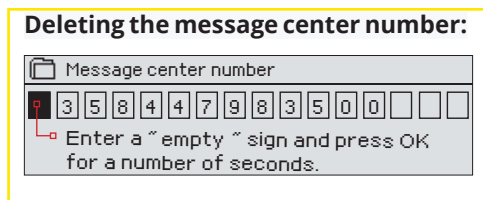
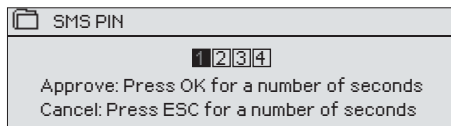

SMS PIN:

Signal strength:

Modem status:

SIM card status:

Device ID:

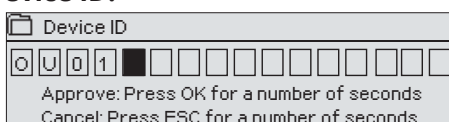

Use of text messaging requires that the GSM modem (optional accessory) is connected to a A203.

Take the GSM modem into use:

1. Enter your PIN
2. Make a blackout.
3. Connect the modem.
4. Switch the power on and the controller initializes the modem and detects the message center. The message center number is read automatically. It should not be set manually (hidden set value). The message center number is not visible on the display when it is read automatically.
5. Check the signal strength and status of modem from A203 display
6. Enter Device ID, if you want.
7. Test the sms communication. Send to A203 a message: Key words. If the controller sends a message where is a list of key words, text message communication is ok. If the SMS communication does not work, check that the message center number has not been entered manually. Press and hold ok to open the hidden menus. If a message center number is entered but the number is incorrect, the number must be entered manually in the format +358. You can check the number with your operator. Another option is to take the SIM out from the modem and set it in the phone and then change the message center via the phone. In this case, delete the message center number from the controller by replacing each character with a "blank" character. Put the SIM card back in the controller. The controller automatically retrieves the message center number (the number is not displayed). Test at communication works.

If the SIM card has PIN inquiry in use, A203 device asks you to enter the PIN.

Entering the code:

- Turn the control knob and press OK to accept each number. Press ESC to return to the previous digit.
- Press OK for a number of seconds to accept the code. Press ESC for a number of seconds to cancel.

Signal strength is expressed with the following descriptions: "Excellent", "Good", "Moderate", "Low", "Very low" and "Initialization failed". If signal strength indicates "No network," try changing the modem's location or use an additional antenna. If the signal strength is "Very low" you should also move the modem to another location to try to improve signal strength. If "Initialisation failed" is stated, check that the SIM card is correctly installed.

A203 recognizes whether the modem is connected or not. The controller initialises the GSM modem automatically.

Mode	Explanation / Instructions
Ok	The modem is ready for use.
Not connected	The modem is not connected or the connection is incorrect.
Mode	Explanation / Instructions
Unregistered	The subscription agreement is not valid.
Registered	The SIM-card is ready for use.
PIN error	Enter A203 controller the same PIN as as the GSM modem's SIM card PIN.
PUK	SIM card is locked (PUK code).

It's possible to define device ID to A203. Device ID works as a password for SMS communication. When device ID is in use, it should be added in front of the keyword in every SMS (e.g. TC01 INPUTS).

8.3 Network settings

System settings > Network settings

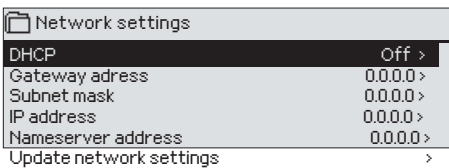
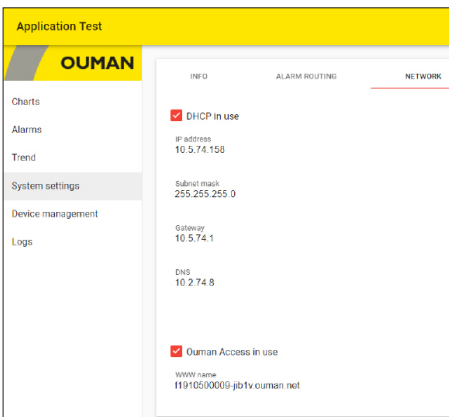
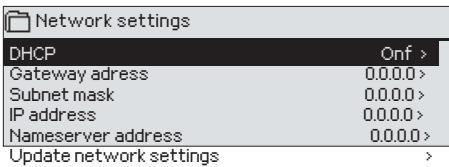
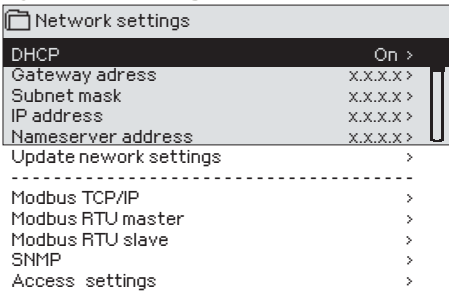

There are two alternative ways to set the A203 device IP address and network settings:

1. IP address is retrieved via DHCP function. This requires that DHCP service is in use in the network and network cables have been connected.
2. IP address is set manually.

Device has fixed Hostname. Hostname can be used to connect to device from Ouflex tool or Ounet.

Connection status indicates whether A203 device is in the network or not. Ouflex A device can be connected to a local network or the Internet. If you use a protected VPN connection using OUMAN Access service, the controller displays the network mode OUMAN Access.

The A203 device should not be connected to a public Internet network without a firewall!

IP settings

Setting the IP address using DHCP function:

1. Go to DHCP and press OK.

Select "On" and press OK to accept selection.

2. Wait approximately one minute. If DHCP is still "Off" after one minute, setting the IP address and network settings was not successful. Either the settings used previously or factory settings have been taken in use. In this case, the device does not necessarily function in the network. The reason for this is usually that the required DHCP service is not in use in the network, or it is out of order, or the network cables have not been connected properly. Check the network cable connections and/or make sure DHCP service is in use.

3. If DHCP is "On", network settings were successfully changed and the device now functions in the network. Device IP address is shown on display.

Setting the IP address manually:

1. When set IP-settings manually you need to ask correct settings in that LAN administrator. OBS. Never try to guess the correct settings. Incorrect settings cause problems, and the network is work properly.
2. Select "Update network settings".

A tip! How to set the network settings easier and faster

You can make setting of the fixed network settings easier

- if you know DHCP service exists in the network
- if you wish to use a fixed IP address.

1. First, set DHCP function **On**. After the settings have been set successfully, set DHCP **Off**.
2. Change **only** IP address manually provided by the network administrator.

Example. There is an Ouman 4G solution to which the A203 is connected. The network uses a DHCP service that shares addresses from 10.200.100 to 10.20.149. The range 10.200.1.1 to 10.200.1.99 is reserved for fixed addresses and the IP address 10.200.1.1 is reserved for the A203 from this range.

Proceed as follows: Set the DHCP function to "On". The DHCP function sets the IP address to a random value of 0.200.1.100. Disable the DHCP service. Set the IP address to 10.200.1.1

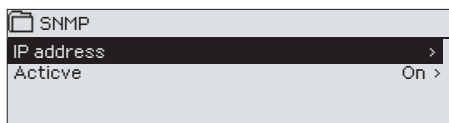
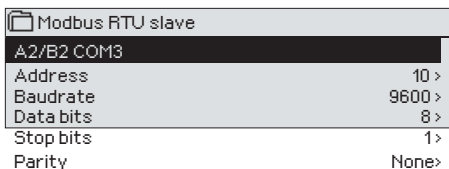
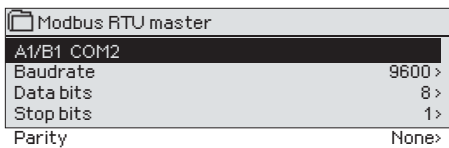
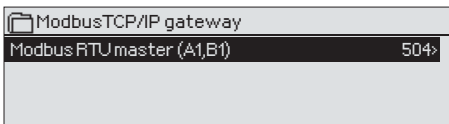
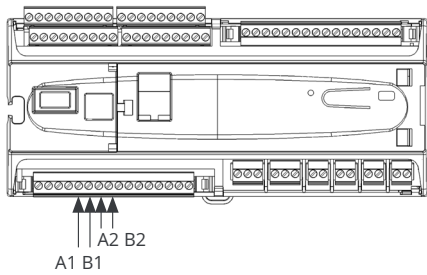
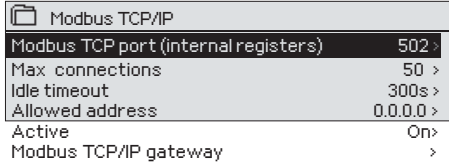
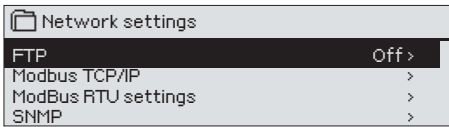

System settings > Network settings->Modbus TCP/IP

Modbus TCP/IP port (internal registers):

Port number 502 is reserved for communication of A203 device. Information of Modbus registers of A203 device are read through this port.

Max connections:

It is possible to decrease server load by changing this setting that defines the maximum number of simultaneous connections from different IP addresses to the server.

Idle timeout:

This setting defines the time after which the server closes an inactive connection.

Allowed address:

It is possible to improve the information security of the system by taking permitted connection address into use. If the value is 0.0.0.0, connections to the server are permitted from any IP address. If you define one permitted connection address, connections to the server are not permitted from any other IP address.

Function on:

This selection either enables or disables the Modbus/TCP communication.

Modbus TCP/IP gateway ->Modbus RTU master (A1,B1):

It is possible to connect a Modbus / RTU fieldbus to the A203. The TCP-port number of the Modbus RTU master (A1,B1) is default 504. This port number acts as a gateway from Modbus/TCP side to Modbus RTU bus of the A203.

System settings > Network settings-> Modbus RTU master (A1, B1)

The A203 can act as a master device on the Modbus-RTU bus (A1, B1 / COM2). The communication port is fixed only for master use.

System settings > Network settings-> Modbus RTU slave (A2, B2)

The A203 can be connected to the Modbus RTU bus (A2, B2 / COM3) as a slave device. The communication port is fixed only for slave use. All necessary bus settings are set here. All devices on the same bus must have a unique device address. In addition, all devices on the same bus must have the same baud rate, the same number of data bits and stop bits, and the same parity.

System settings > Network settings-> SNMP

SNMP

SNMP function can be used to send notifications about alarms activating, inactivating and being acknowledged via SNMP protocol to a desired server.

IP address

The IP address of the target server to which messages are sent. Ounet IP address is a default.

Active

This selection either enables or disables the entire SNMP function.

System settings > Network settings > Access settings



OUMAN ACCESS – service enables you to make a remote connection (useful with Ounet use) to A203 device from internet without any extra hardware. **It is sufficient that a firewall-protected Internet connection with standard LAN technology is available and that the service is not blocked.**

A203 device can be connected to LAN if following conditions are fulfilled:

1. LAN is routed via Internet

The Access service operates on the Internet so the Access service is not available if the device is not connected to the Internet. The Access device examines the availability of Internet connection by sending a Ping packet to the Internet server at 3-minute intervals. The network must allow the ICMP outwards from any port and the receipt of the reply message to the same port.

2. The VPN protocol used by Access service outwards is not blocked

The Access service is based on the VPN connection which the Access device creates to the Access server. The network must allow the UDP outwards from any port to the port 1194 and the receipt of the reply message to this port.

3. Time service protocol outwards is not blocked

The Access service works only when the clock in the Access device shows the correct time. The clock is set to the correct time automatically from the network using the NTP protocol. The network must allow the UDP outwards from any port to the port 123 and the receipt of the reply message to this port.

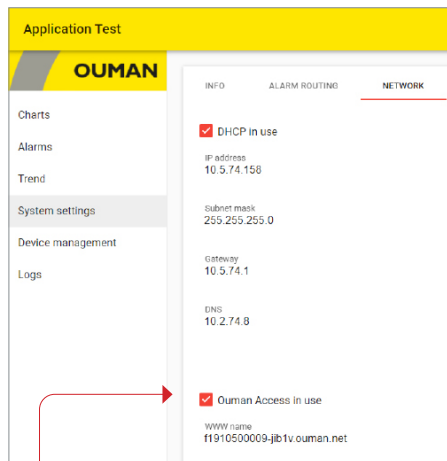
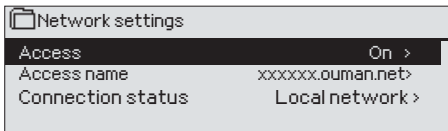

See page 49 for more information on the WEB interface.

Note! If you disable Ouman Access, you will lose your Internet connection to your device. You can connect to the device from the local network using an IP address or a direct cable connection.

8.4 Display settings

System settings > Display settings

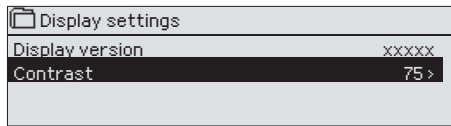

Contrast:

You can adjust the contrast of the display. If you wish the display to be brighter, set a smaller numerical value. The setting range is 50... 100. New setting is taken in use after confirmation is done.

8.5 Type information

System settings > Type information

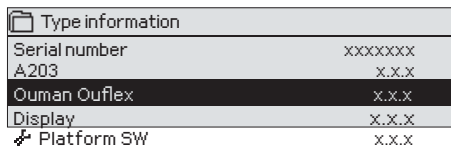

Type information shows the hardware and software versions. This information is useful especially in case of maintenance or upgrade.

TYPE INFORMATION

Send message: Type information.

The reply message will show information about the device and software.

8.6 Lock code

System settings > Lock code

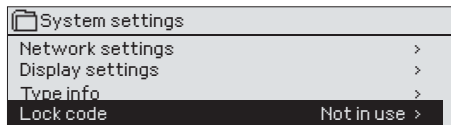

When lock code is taken in use, it's not possible to change any settings without entering lock code. It is recommended that you take lock code into use if the device is located so that anyone could reach it and change settings (e.g. deactivate burglar monitoring). Locking the device and changing the lock code prevents unauthorized use of the device.

Lock code function	Description
Not in use	You can read A203 device information and change settings.
In use	You can read A203 device information but you can not change settings without entering the lock code. The factory setting of lock code is 0000. If you take lock code into use, change the code for security reasons.

System settings > Change lock code

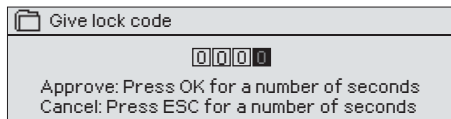

If you have taken lock code into use, you may change the code. The factory setting of lock code is 0000.

1. A203 device asks you to enter the current code. The factory setting of lock code is 0000.
2. Turn the control knob and press OK to accept each number. Press ESC to return to the previous square.
3. Press OK for a number of seconds to accept the code. Press ESC for a number of seconds to cancel.

NOTE! When you enter a locking code when changing the default, the code will not be required again until the unit has been untouched for 10 minutes, when the display goes into idle state. You can also set the display in idle state by pressing the ESC button for a long period of time.

1 2 Alternative connections M4, M7, M12, M13 and M14

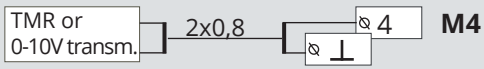
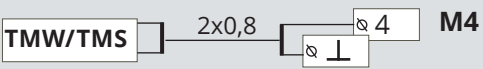
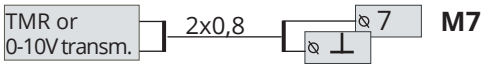
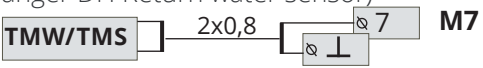
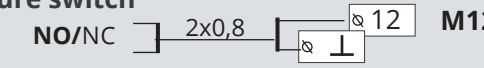
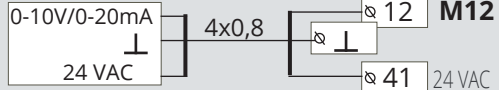
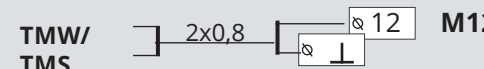
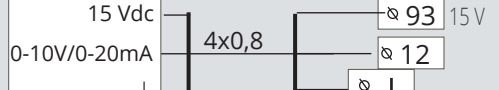
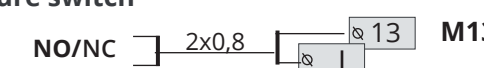
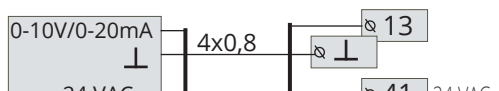
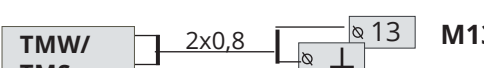
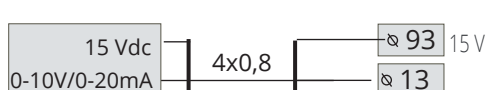
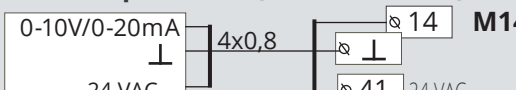
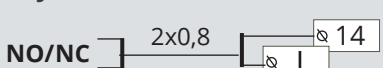
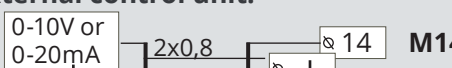
<p>M4: H1 Room temperature measurement</p> 	<p>M4: Temperature measurement (H1 Heat exchanger DH Return water sensor)</p> 	MEAS. 4
<p>M7: H2 Room temperature measurement</p> 	<p>M7: Temperature measurement (H2 Heat exchanger DH Return water sensor)</p> 	MEAS. 7
<p>M12: Pressure switch</p> <p>NO/NC</p> 	<p>M12: Pressure transmitter with AC supply</p> 	MEAS. 12
<p>M12: General temperature measurement</p> <p>TMW/TMS</p> 	<p>M12: Pressure transmitter with DC supply</p> 	
<p>M13: Pressure switch</p> <p>NO/NC</p> 	<p>M13: Pressure transmitter with AC supply</p> 	MEAS. 13
<p>M13: General temperature measurement</p> <p>TMW/TMS</p> 	<p>M 13: Pressure transmitter with DC supply</p> 	
<p>M14: General compensation(0-10V, 0-20 mA)</p> 	<p>M14: Home-Away switch</p> <p>NO/NC</p> 	MEAS. 14
<p>M14: General compensation, Transmitter measurement from external control unit.</p> 		

Triac controls

3 4 Analog outputs

Actuators control of H1 Heating circuit

3-point controlled actuator

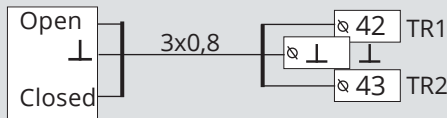

H1 Voltage controlled actuator

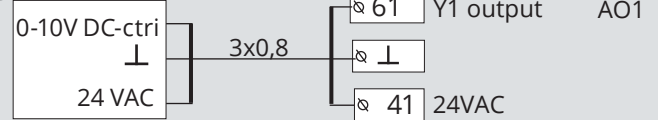

*) Connect 24 VAC to strip connector 42, if it is selected that Manual mechanical control is "available" (see Service -> Connections and configuration -> H1 Actuator control)

H1 Voltage controlled actuator 2, serial driving

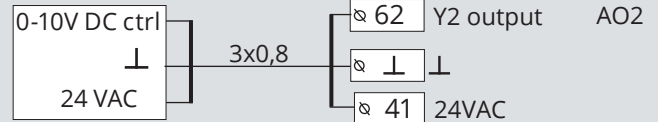

Actuators control of H2 Heating circuit

3-point controlled actuator

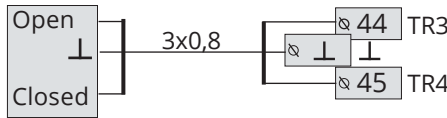

Note! The 3-point actuator cannot be used simultaneously in the H2 and DHW control circuits.

H2 Voltage controlled actuator

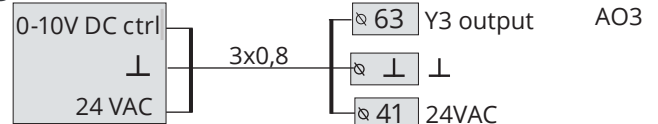

*) Connect 24 VAC to strip connector 44, if it is selected that Manual mechanical control is "available" (see Service -> Connections and configuration -> H2 Actuator control)

H2 Voltage controlled actuator 2, serial driving

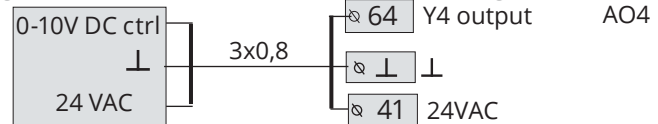

Actuators control of DHW Heating circuit

3-point controlled actuator

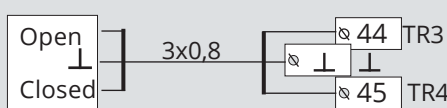

Note! The 3-point actuator cannot be used simultaneously in the H2 and DHW control circuits.

DHW Voltage controlled actuator

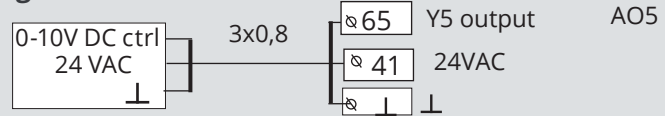

*) Connect 24 VAC to strip connector 45, if it is selected that Manual mechanical control is "available" (see Service -> Connections and configuration -> DHW Actuator control)

DHW Voltage controlled actuator 2, serial driving

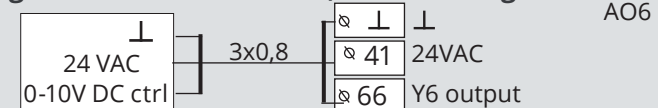

5 6 Relay control

Pump control

P2.1 Pump control (H1)

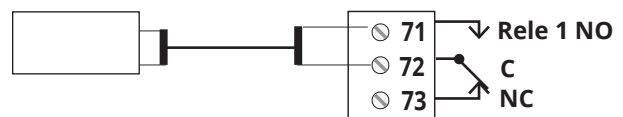

P2.2 Pump control (H1 backup pump-/alternate pump)

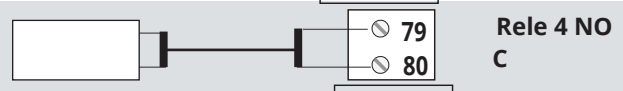
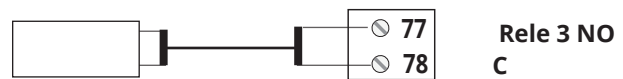
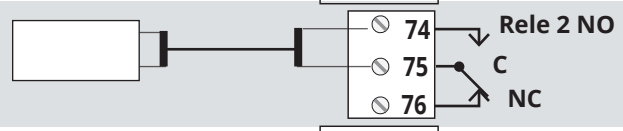

Water leak solenoid valve or Control of heating, cooling or smelting thermostat or time program control

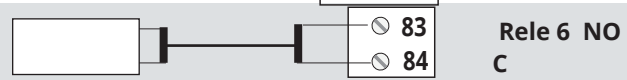

Other connections

Power supply

Operating voltage	24 Vac, 50 Hz (22 Vac - 33 Vac)
Power required	(15 Vdc output =if not connected) 13 VA (15 Vdc output = 750 mA) 34 VA In addition, the operating voltage of 24 Vac and the power requirement of the Triac outputs must be taken into attention. Maximum total current limit is 4A. Then maximum supply power need is 96 VA. (Max 1A/triac pair)
Backup input	12 Vdc
Current consumption	300mA / 3,6W (relays not in use) 400mA / 4,8W (relays in use)



Modbus RTU connection:

Twisted pair cable is used to connect RTU devices, e.g. DATAJAMAK 2 x (2 + 1) x 0.24. The bus cable's shield (FE) is connected to the BG connector of the A203. In the master device the shield can be left disconnected or be connected to a potential free contact. A 120 Ω terminating resistor is connected to both ends of the bus.

The factory default for the device's slave address is 10 and the bus speed is 9600 bauds. If necessary, make changes in the "System settings".

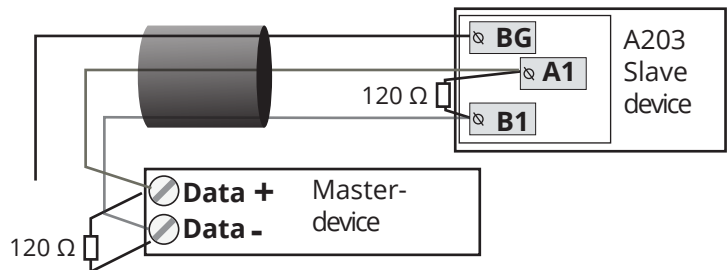

9.1 Connections and configuration

Connections and configuration	
M1: Outdoor temp.	In use >
M2: H1 Supply water	In use >
M3: H1 Return water	Not in use >
M4: Measurement 4	Not in use >

The user interface is grouped according to the control circuits and the functions.

When you press OK on the input/output, opens a menu, where you can review and edit the settings.

M1: Outdoor temperature	
Measurement status	In use >
Outdoor temp.	-2.4 °C >
Measurement adjustment	0.0 °C >
Sensor type	NTC10 >

- you can take in use the input/output
- you can read the measurement. When you press OK you can set the meas. to manual mode and give the constant temperature. If the measurement is on manual mode, the hand symbol is shown in the beginning of the line.
- If the measurement shows 0.5 °C too much, set the offset to -0.5 °C
- You can choose between the measurement channels M1 to M13 as the type of sensor: 'NTC10', 'NTC1.8', 'NTC2.2', 'NTC20', 'Ni1000LG', 'Ni1000DIN' or 'Pt1000'.
- In addition you can rename inputs and outputs, see p. 39.

If the sensor is defective, the measurement value shown will be -50°C or 130 °C.

Tip: If you want to take the inputs into use before the sensors are connected, you can avoid unnecessary sensor fault alarms by disabling alarms from Service mode -> Alarm settings->Alarms: "Disabled".

Check the functions which have been taken in use in the controller.

Inputs	Alternative measurement options
M1 Outdoor temp.	<input type="checkbox"/> In use
M2 H1 Supply water	<input type="checkbox"/> In use
M3 H1 Return water	<input type="checkbox"/> In use -> <input type="checkbox"/> H1 Return water compensation
M4 Meas. 4	<input type="checkbox"/> Temperature measurement-> Name: , specify _____ <input type="checkbox"/> H1 Room temp. <input type="checkbox"/> H1 Room temp. 0...10 V -> <input type="checkbox"/> H1 DH Return <div style="border: 1px solid black; padding: 5px; margin-top: 5px;"> Message scaling (Room temp. 0...10 V) Temperature minimum _____ (0.0 °C) Temperature max _____ (50.0 °C) </div>
M5 H2 Supply water	<input type="checkbox"/> In use
M6 H2 Return water	<input type="checkbox"/> In use -> <input type="checkbox"/> H2 Return water compensation
M7 Meas. 7	<input type="checkbox"/> Temperature measurement -> Name, specify _____ <input type="checkbox"/> H2 Room temp. <input type="checkbox"/> H2 Room temp. 0...10 V -> <input type="checkbox"/> H2 DH Return <div style="border: 1px solid black; padding: 5px; margin-top: 5px;"> Message scaling (Room temp. 0...10 V) Temperature minimum _____ (0.0 °C) Temperature max _____ (50.0 °C) </div>
M8 DHW Domestic hot water	<input type="checkbox"/> In use
M9 DHW Circulation water	<input type="checkbox"/> In use
M10 Meas. 10	<input type="checkbox"/> Temperature measurement <input type="checkbox"/> Switch alarm Name: Switch alarm (M10), other, specify _____ <div style="display: flex; justify-content: space-between; margin-top: 10px;"> <div style="border: 1px solid black; padding: 5px; width: 45%;"> Switch alarm: Digital input type: <input type="checkbox"/> normally open <input type="checkbox"/> normally closed Alarm entry delay _____(30s) Alarm priority ____ (1=Emergency) </div> <div style="border: 1px solid black; padding: 5px; width: 45%;"> Temperature measurement: M 10 Alarm entry delay ____ (60 s) M 10 Alarm max limit ____ (131 °C) M 10 Alarm min limit ____ (-51 °C) Alarm priority ____ (1= Emergency) Name of meas.: DH Supply, other specify _____ </div> </div>
M11 Meas. 11	<input type="checkbox"/> Temperautre measurement <input type="checkbox"/> Switch alarm Name: M11 Switch alarm mode , other, specify _____ <div style="display: flex; justify-content: space-between; margin-top: 10px;"> <div style="border: 1px solid black; padding: 5px; width: 45%;"> Switch alarm: Digital input type: <input type="checkbox"/> normally open <input type="checkbox"/> normally closed Alarm entry delay _____(30s) Alarm priority ____ (1=Emergency) </div> <div style="border: 1px solid black; padding: 5px; width: 45%;"> Temperature measurement: M 11 Alarm entry delay ____ (60 s) M 11 Alarm max limit ____ (131 °C) M 11 Alarm min limit ____ (-51 °C) Alarm priority ____ (Emergency) Name of meas.: DH Return temp, other specify _____ </div> </div>

Inputs	Alternative measurement options	Attention
M12 Meas. 12	<input type="checkbox"/> Temperature measurement > <input type="checkbox"/> Pressure switch <input type="checkbox"/> Pressure transmitter V <input type="checkbox"/> Pressure transmitter mA	Name: Meas. M12; other specify _____ <div style="border: 1px solid black; padding: 5px; display: inline-block;"> Pressure switch: Digital input type: <input type="checkbox"/> normally open <input type="checkbox"/> normally closed </div> <div style="border: 1px solid black; padding: 5px; display: inline-block; margin-left: 20px;"> Pressure transmitter: Pressure measurement 1: Automatic/manual Measuring area ____ (10.0 bar) Measurement adjustment ____ (0.0) Name: (Pressure measurement 1), other specify _____ Pressure meas. 1 high limit alarm: ____ (10.0bar) Pressure meas. 1 low limit alarm: ____ (0.5bar) </div>
M13 Meas. 13	<input type="checkbox"/> Temperature measurement > <input type="checkbox"/> Pressure switch <input type="checkbox"/> Pressure transmitter V <input type="checkbox"/> Pressure transmitter mA <input type="checkbox"/> Moisture sensor	Name: Meas. M13; other specify _____ <div style="border: 1px solid black; padding: 5px; display: inline-block;"> Pressure switch: Digital input type: <input type="checkbox"/> normally open <input type="checkbox"/> normally closed </div> <div style="border: 1px solid black; padding: 5px; display: inline-block; margin-left: 20px;"> Pressure transmitter: Pressure measurement 2: Automatic/manual Measuring area ____ (10.0 bar) Measurement adjustment ____ (0.0) Name: (Pressure measurement 2), other specify _____ Pressure meas. 2 high limit alarm: ____ (10.0bar) Pressure meas. 2 low limit alarm: ____ (0.5bar) </div>
M14 Meas. 14	<input type="checkbox"/> General compens. 0-10 V, <input type="checkbox"/> General compens. 0-20 mA, <input type="checkbox"/> Home/Away switch	General compensation: automatic/manual. You can define with circuit-specific set. You can assign names to general compensation (e.g. solar compensation, wind compensation or pressure compensation). Home/Away control: The control will be taken separately in use (see Service -> Temperature drops). You can also do Home/Away control in "Inputs and Outputs"-menu or by SMS message /"Home"/"Away", requires GSM-modedm).

ALARMS, INDICATIONS AND PULSE MEASUREMENTS

Input / Output	Alternative measurement options	Attention
M15 Alarm 15	<input type="checkbox"/> P2.1 Indication -> <input type="checkbox"/> P2.1 Alarm-> Alarm priority __ (1=Emergency)	Digital input type: <input type="checkbox"/> normally open <input type="checkbox"/> normally closed Name: _____
M16 Alarm 16	<input type="checkbox"/> P3.1 Indication -> <input type="checkbox"/> P3.1 Alarm -> <input type="checkbox"/> P2.2 Indication-> <input type="checkbox"/> P2.2 Alarm Alarm priority __ (1=Emergency)	Digital input type: <input type="checkbox"/> normally open <input type="checkbox"/> normally closed Name: _____
D11 Digital input 17	<input type="checkbox"/> P1 Alarm-> <input type="checkbox"/> General alarm -> <input type="checkbox"/> Water flow meas. <input type="checkbox"/> Energy measurement <input type="checkbox"/> P2.2 Indication-> <input type="checkbox"/> P2.2 Alarm -> <input type="checkbox"/> P3.2 Indication -> <input type="checkbox"/> P3.2 Alarm ->	Digital input type: <input type="checkbox"/> normally open <input type="checkbox"/> normally closed Name: _____ Alarm priority __ (1) (1=Emergency) General alarm: Nameable alarm.
D12 Digital input 18	<input type="checkbox"/> Water flow meas. <input type="checkbox"/> Energy measurement <input type="checkbox"/> P2.2 Indication-> <input type="checkbox"/> P2.2 Alarm -> <input type="checkbox"/> P3.2 Indication -> <input type="checkbox"/> P3.2 Alarm ->	Digital input type: <input type="checkbox"/> normally open <input type="checkbox"/> normally closed Name: _____ Alarm priority __ (1) 1=Emergency)

Pump indication can be selected only if the pump control is taken in use. A contradiction alarm will be activated if the controller sets pump on but it's not started. The alarm has a 5 s delay.

Pulse measurement settings:
Water volume
 Pulse input scaling: ____ 10 l/pulse (setting range 1 ... 100 l/pulse)
 Counter initial value: ____ 0.0 m3
 Name of meas. DI1(2) Water volume _____
Energy measurement
 Pulse input scaling: ____ 10 kWh/pulse (setting range 1 ... 100 kWh/pulse)
 Counter initial value: ____ 0.0 MWh
 Name of meas. DI1(2) Energy measurement _____

ACTUATOR CONTROLS

Name	Output	Actuator selection	Running time / factory setting (setting range)
H1 Actuator control	AO1	<input type="checkbox"/> 0-10 V / <input type="checkbox"/> 2-10 V /	Running time open ___ 150 s (10...500 s)
	AO1	<input type="checkbox"/> 10-0 V / <input type="checkbox"/> 10-2 V	Running time close ___ 150 s (10...500 s)
	TR1, TR2	<input type="checkbox"/> 3-point (TR1, TR2)	<input type="checkbox"/> Manual mech. control available -> The TR1 (connector 42) is reserved for voltage controlled actuator (24 VAC).
H2 Actuator control	AO3	<input type="checkbox"/> 0-10 V / <input type="checkbox"/> 2-10 V /	Running time open ___ 150 s (10...500 s)
	AO3	<input type="checkbox"/> 10-0 V / <input type="checkbox"/> 10-2 V	Running time close ___ 150 s (10...500 s)
	TR3, TR4	<input type="checkbox"/> 3-point (TR3, TR 4)	<input type="checkbox"/> Manual mech. control available -> The TR3 (connector 44) is reserved for voltage controlled actuator (24 VAC).
DHW Actuator control	AO5	<input type="checkbox"/> 0-10 V / <input type="checkbox"/> 2-10 V	Running time open ___ 15 s (5...500 s)
	AO5	<input type="checkbox"/> 10-0 V / <input type="checkbox"/> 10-2 V	Running time close ___ 15 s (5...500 s)
	TR3, TR4	<input type="checkbox"/> 3-point (TR5, TR 6)	-> The TR4 (connector 45) is reserved for voltage controlled actuator (24 VAC).
H1 Actuator control 2 (serial driving)	AO2	<input type="checkbox"/> 0-10 V / <input type="checkbox"/> 2-10 V	Running time ___ 150 s (10...500 s)
	AO2	<input type="checkbox"/> 10-0 V / <input type="checkbox"/> 10-2 V	
H2 Actuator control 2 (serial driving)	AO4	<input type="checkbox"/> 0-10 V / <input type="checkbox"/> 2-10 V	Running time ___ 150 s (10...500 s)
	AO4	<input type="checkbox"/> 10-0 V / <input type="checkbox"/> 10-2 V	
DHW Actuator control 2 (serial driving)	AO6	<input type="checkbox"/> 0-10 V / <input type="checkbox"/> 2-10 V	Running time ___ 15 s (5...500 s)
	AO6	<input type="checkbox"/> 10-0 V / <input type="checkbox"/> 10-2 V	

PUMP CONTROLS

Name	Output	Double pump function	Control mode and Manual position	Attention!
P2.1 Pump control (H1)	R1		<input type="checkbox"/> Automatic <input type="checkbox"/> Manual -> <input type="checkbox"/> Stop <input type="checkbox"/> Run	.
P3.1 Pump control (H2)	R2		<input type="checkbox"/> Automatic <input type="checkbox"/> Manual -> <input type="checkbox"/> Stop <input type="checkbox"/> Run	
P2.2 Pump control (H1)	R3	<input type="checkbox"/> Alternate pump <input type="checkbox"/> Backup pump	<input type="checkbox"/> Automatic <input type="checkbox"/> Manual -> <input type="checkbox"/> Stop <input type="checkbox"/> Run	Pumps run time period_7 (1...365 days)
P3.2 Pump control (H2)	R4	<input type="checkbox"/> Alternate pump <input type="checkbox"/> Backup pump	<input type="checkbox"/> Automatic <input type="checkbox"/> Manual -> <input type="checkbox"/> Stop <input type="checkbox"/> Run	Pumps run time period_7 (1...365 days)

Backup pump/ Automatic: Backup pump/ Automatic: If pump P2.1/ P3.1 goes into a malfunction the controller automatically switches on the backup pump (P 2.2/ P3.2) and gives an alarm from pump P2.1/ P3.1. Backup pump interval use: The controller drives the main pump (P2.1/ P3.1) once a week, on Mondays at 8.00-8.01 and the backup pump (P 2.2/ P3.2) 8.01-8.02.

Alternate pump/ Automatic: Pumps 1 and 2 are controlled by the controller to function on alternate time periods as a main pump. The other pump then functions as a backup pump. If pump goes into a malfunction the controller automatically switches on the backup pump and gives an alarm from main pump. The pumps are used alternatively so they both get the same amount of wear and thus have a longer lifespan. The operation of the pumps is measured by a running time counter. The pumps are alternated so that during the pump run time period the controller uses pump 1 half the time and pump 2 half the time. The pump run time period is adjustable (Default 7 days, setting range 1 ... 365 days) Interval operation also works in the alternating pump case. During interval operation, the co-pump is stopped, so only one pump runs at a time.

SUM ALARM

Relay (NO, C)	Control mode	Setting values (default)	Meas. controlling the relay/Name of control
R6 (83, 84)	Sum alarm	<input type="checkbox"/> 1-class <input type="checkbox"/> 2-class <input type="checkbox"/> 1- or 2-class	Class 1 is for alarms classified as urgent that should always be immediately forwarded. These include freezing risk alarms, pump alarms or sensor fault in supply water. Class 2 includes e.g. room and outdoor temperature sensor fault alarms.

Relay control

Output	Control mode	Setting values (default)	Meas. controlling the relay/Name of control																																																					
Relay control R5 (81, 82)	<input type="checkbox"/> Heating thermostat <input type="checkbox"/> Cooling thermostat <input type="checkbox"/> Defrost thermostat <input type="checkbox"/> Heat. therm.& time ctrl <input type="checkbox"/> Cool. therm.& time ctrl <input type="checkbox"/> Defr. therm.& time ctrl <input type="checkbox"/> Time control	Heating/ Cooling thermostat: Setting value ____ (21.0°C) Hysteresis ____ (1.0 °C) Defrost thermostat: Temperature limit 1 ____ (5°C) Temperature limit 2 ____ (-5.0 °C)	<input type="checkbox"/> Outdoor temperature <input type="checkbox"/> Measurement 10 Name of control (TR5 control) other, specify _____ <table border="1"> <thead> <tr> <th colspan="8">Time control: Weekly schedule</th> </tr> <tr> <th>Time</th> <th>Mode</th> <th>M</th> <th>T</th> <th>W</th> <th>T</th> <th>F</th> <th>S</th> <th>S</th> </tr> </thead> <tbody> <tr> <td><input type="checkbox"/></td> <td>ON</td> <td><input type="checkbox"/></td> <td><input type="checkbox"/></td> <td><input type="checkbox"/></td> <td><input type="checkbox"/></td> <td><input type="checkbox"/></td> <td><input type="checkbox"/></td> <td><input type="checkbox"/></td> </tr> <tr> <td><input type="checkbox"/></td> <td>OFF</td> <td><input type="checkbox"/></td> <td><input type="checkbox"/></td> <td><input type="checkbox"/></td> <td><input type="checkbox"/></td> <td><input type="checkbox"/></td> <td><input type="checkbox"/></td> <td><input type="checkbox"/></td> </tr> <tr> <td><input type="checkbox"/></td> <td>ON</td> <td><input type="checkbox"/></td> <td><input type="checkbox"/></td> <td><input type="checkbox"/></td> <td><input type="checkbox"/></td> <td><input type="checkbox"/></td> <td><input type="checkbox"/></td> <td><input type="checkbox"/></td> </tr> <tr> <td><input type="checkbox"/></td> <td>OFF</td> <td><input type="checkbox"/></td> <td><input type="checkbox"/></td> <td><input type="checkbox"/></td> <td><input type="checkbox"/></td> <td><input type="checkbox"/></td> <td><input type="checkbox"/></td> <td><input type="checkbox"/></td> </tr> </tbody> </table>	Time control: Weekly schedule								Time	Mode	M	T	W	T	F	S	S	<input type="checkbox"/>	ON	<input type="checkbox"/>	<input type="checkbox"/>	<input type="checkbox"/>	<input type="checkbox"/>	<input type="checkbox"/>	<input type="checkbox"/>	<input type="checkbox"/>	<input type="checkbox"/>	OFF	<input type="checkbox"/>	<input type="checkbox"/>	<input type="checkbox"/>	<input type="checkbox"/>	<input type="checkbox"/>	<input type="checkbox"/>	<input type="checkbox"/>	<input type="checkbox"/>	ON	<input type="checkbox"/>	<input type="checkbox"/>	<input type="checkbox"/>	<input type="checkbox"/>	<input type="checkbox"/>	<input type="checkbox"/>	<input type="checkbox"/>	<input type="checkbox"/>	OFF	<input type="checkbox"/>	<input type="checkbox"/>	<input type="checkbox"/>	<input type="checkbox"/>	<input type="checkbox"/>	<input type="checkbox"/>	<input type="checkbox"/>
Time control: Weekly schedule																																																								
Time	Mode	M	T	W	T	F	S	S																																																
<input type="checkbox"/>	ON	<input type="checkbox"/>	<input type="checkbox"/>	<input type="checkbox"/>	<input type="checkbox"/>	<input type="checkbox"/>	<input type="checkbox"/>	<input type="checkbox"/>																																																
<input type="checkbox"/>	OFF	<input type="checkbox"/>	<input type="checkbox"/>	<input type="checkbox"/>	<input type="checkbox"/>	<input type="checkbox"/>	<input type="checkbox"/>	<input type="checkbox"/>																																																
<input type="checkbox"/>	ON	<input type="checkbox"/>	<input type="checkbox"/>	<input type="checkbox"/>	<input type="checkbox"/>	<input type="checkbox"/>	<input type="checkbox"/>	<input type="checkbox"/>																																																
<input type="checkbox"/>	OFF	<input type="checkbox"/>	<input type="checkbox"/>	<input type="checkbox"/>	<input type="checkbox"/>	<input type="checkbox"/>	<input type="checkbox"/>	<input type="checkbox"/>																																																
Relay control R6 (83, 84)	<input type="checkbox"/> Heating thermostat <input type="checkbox"/> Cooling thermostat <input type="checkbox"/> Defrost thermostat <input type="checkbox"/> Heat. therm.& time ctrl <input type="checkbox"/> Cool. therm.& time ctrl <input type="checkbox"/> Defr. therm.& time ctrl <input type="checkbox"/> Time control	Heating/ Cooling thermostat: Setting value ____ (21.0°C) Hysteresis ____ (1.0 °C) Defrost thermostat: Temperature limit 1 ____ (5°C) Temperature limit 2 ____ (-5.0 °C)	<input type="checkbox"/> Outdoor temperature <input type="checkbox"/> Measurement 11 Name of control (TR6 control) other, specify _____ <table border="1"> <thead> <tr> <th colspan="8">Time control: Weekly schedule</th> </tr> <tr> <th>Time</th> <th>Mode</th> <th>M</th> <th>T</th> <th>W</th> <th>T</th> <th>F</th> <th>S</th> <th>S</th> </tr> </thead> <tbody> <tr> <td><input type="checkbox"/></td> <td>ON</td> <td><input type="checkbox"/></td> <td><input type="checkbox"/></td> <td><input type="checkbox"/></td> <td><input type="checkbox"/></td> <td><input type="checkbox"/></td> <td><input type="checkbox"/></td> <td><input type="checkbox"/></td> </tr> <tr> <td><input type="checkbox"/></td> <td>OFF</td> <td><input type="checkbox"/></td> <td><input type="checkbox"/></td> <td><input type="checkbox"/></td> <td><input type="checkbox"/></td> <td><input type="checkbox"/></td> <td><input type="checkbox"/></td> <td><input type="checkbox"/></td> </tr> <tr> <td><input type="checkbox"/></td> <td>ON</td> <td><input type="checkbox"/></td> <td><input type="checkbox"/></td> <td><input type="checkbox"/></td> <td><input type="checkbox"/></td> <td><input type="checkbox"/></td> <td><input type="checkbox"/></td> <td><input type="checkbox"/></td> </tr> <tr> <td><input type="checkbox"/></td> <td>OFF</td> <td><input type="checkbox"/></td> <td><input type="checkbox"/></td> <td><input type="checkbox"/></td> <td><input type="checkbox"/></td> <td><input type="checkbox"/></td> <td><input type="checkbox"/></td> <td><input type="checkbox"/></td> </tr> </tbody> </table>	Time control: Weekly schedule								Time	Mode	M	T	W	T	F	S	S	<input type="checkbox"/>	ON	<input type="checkbox"/>	<input type="checkbox"/>	<input type="checkbox"/>	<input type="checkbox"/>	<input type="checkbox"/>	<input type="checkbox"/>	<input type="checkbox"/>	<input type="checkbox"/>	OFF	<input type="checkbox"/>	<input type="checkbox"/>	<input type="checkbox"/>	<input type="checkbox"/>	<input type="checkbox"/>	<input type="checkbox"/>	<input type="checkbox"/>	<input type="checkbox"/>	ON	<input type="checkbox"/>	<input type="checkbox"/>	<input type="checkbox"/>	<input type="checkbox"/>	<input type="checkbox"/>	<input type="checkbox"/>	<input type="checkbox"/>	<input type="checkbox"/>	OFF	<input type="checkbox"/>	<input type="checkbox"/>	<input type="checkbox"/>	<input type="checkbox"/>	<input type="checkbox"/>	<input type="checkbox"/>	<input type="checkbox"/>
Time control: Weekly schedule																																																								
Time	Mode	M	T	W	T	F	S	S																																																
<input type="checkbox"/>	ON	<input type="checkbox"/>	<input type="checkbox"/>	<input type="checkbox"/>	<input type="checkbox"/>	<input type="checkbox"/>	<input type="checkbox"/>	<input type="checkbox"/>																																																
<input type="checkbox"/>	OFF	<input type="checkbox"/>	<input type="checkbox"/>	<input type="checkbox"/>	<input type="checkbox"/>	<input type="checkbox"/>	<input type="checkbox"/>	<input type="checkbox"/>																																																
<input type="checkbox"/>	ON	<input type="checkbox"/>	<input type="checkbox"/>	<input type="checkbox"/>	<input type="checkbox"/>	<input type="checkbox"/>	<input type="checkbox"/>	<input type="checkbox"/>																																																
<input type="checkbox"/>	OFF	<input type="checkbox"/>	<input type="checkbox"/>	<input type="checkbox"/>	<input type="checkbox"/>	<input type="checkbox"/>	<input type="checkbox"/>	<input type="checkbox"/>																																																

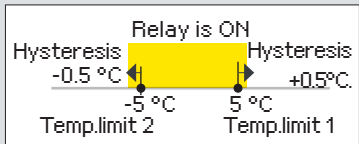

Renaming

Name of meas.:

G e n e r a l c o m p e n s a

Approve: Press OK a number of seconds
 Cancel: Press ESC a number of seconds

Navigate to "Name of measurement" and press OK. A naming dialogue will open. Turn the selection knob and accept a letter by pressing OK.

Continue to the next input field by pressing OK.

Return to the previous input field by pressing ESC.

Press OK for extended period of time to accept.

Press Esc for extended period of time to exit without saving any changes.

10 Service settings

Service mode includes all settings of the controller. Some of the settings can be found also from "setting" menus of the heating circuits (H1, H2, DHW).

CONTROL CIRCUIT SETTINGS			
Setting	Factory setting	Range	Explanation
Control circuit	In use	In use/ Not in use	Control circuits are already taken into use in start-up wizard. If you want to have the control disabled, select "Not in use".
Heating circuit	H1: Radiator heating H2: Floor heating	Radiator heating/ Floor heating	If the radiator heating is chosen as a heating mode, the controller uses the outdoor temperature delay in supply water control (see. Radiator heating delay). If you have selected the floor heating, the controller uses the outdoor temperature anticipation in supply water control (see. Floor heating anticipation).
Parallel shift	0.0	-15 ... +15 °C	If room temperature is continuously above or below the setting value despite the outdoor temperature, you can add a permanent compensation value to the supply water setting value.
Parallel shift damping point	7.0	-20 ... +20 °C	Outdoor temperature set by the user at which the effect of parallel shift begins to dampen. When the outdoor temperature reaches +20°C, the effect of parallel shift has already completely stopped. The factory default setting for the damping point is 7°C. At a value setting of more than 17°C parallel shift damping is not enabled (the function is not available if room temperature measurement is connected).
Min.limit	18.0 °C	0 ... 99 °C	The low limit for supply water. For comfort reasons, the higher low limit is used in bath rooms than e.g. in rooms with parquet floor. This also removes the moisture from path rooms at summer time (see more information page 11).
Max.limit	45 °C	0 ... 99 °C	High limit of supply water (see page 11).
Actuator calibration	In use	Not in use/In use	Calibration takes place every time the controller starts and once a week on Mondays at 9.00. The controller first completely closes the valve and then opens to the position determined by the controller.
DHW Control circuit	In use	In use/ Not in use	The control circuits will be taken into use already in start up wizard. If you want to have the control disabled, select "Not in use".
DHW Domestic hot water setting value	58.0 °C	20 ... 90 °C	DHW Supply water temperature setting.
DHW reduction/ incr. Time prog.	Not in use	In use/ Not in use	Domestic hot water increases and drops can be made by DHW time program. The change of temperature setting value is made either by the week calendar or exception calendar.
DHW reduction amount	10.0 °C	0 ... 30 °C	The amount of drop in domestic hot water drop/increase time programs.
DHW increment amount	10.0 °C	0 ... 30 °C	The amount of increase in domestic hot water drop/increase time programs.
Actuator calibration	In use	Not in use/In use	Calibration takes place every time the controller starts and once a week on Mondays at 9.00. The controller first completely closes the valve and then opens to the position determined by the controller.
Temperature drops			
Temperature drop		0... 40 °C	Temperature drop of supply water, which be triggered from time program or a Home/Away text message command or when selecting continuous temperature drop as circuit's control mode. If room temperature measurement has been taken into use, the temperature drop is given as a room temperature drop.
Radiator heating	3.0		
Floor heating	1.5		
Supply water pre-increase		0... 25 °C	The amount of the automatic supply water pre-increase occurring at the end of the temperature drop (time program) The pre-increase helps raise the room temperature more quickly back to a nominal room temperature after a temperature drop.
Radiator heating	4.0		
Floor heating	1.5		

Setting	Factory setting	Range	Explanation
Supply water pre-increase	In use	In use/ Not in use	<p>Room temperature can be increased to normal more quickly after temperature drop by using the preliminary increase function.</p>
Pre-increase time	1	0... 10 h	The pre-increase time defines the time, when the pre-increase is started. If pre-increase time is one hour, the pre-increase will start one hour before the time program ends the temperature drop (returning to normal temperature).
Home/Away control	Not in use	In use/ Not in use	The Home/Away control changes the temperature levels. If transmitter for general compensation is connected to controller, it's not possible to connect Home/Away switch. In this case Home/Away mode can be switched with SMS or from "Inputs and Outputs" menu.
Delay function of radiator heating			
Outd.temp.delay on temp.drop	2.0	0... 15 h	Outdoor temperature delay is in use, if the radiator heating is selected as a heating mode in the control circuit settings. The amount of the outdoor temperature delay is defined with "Outd.temp.delay on temp.drop" setting. The delayed outdoor temperature is used for regulating the supply water temperature. The typical outdoor temperature delay for radiator heating is 2 hours. If the room temperature rises too much when temperatures lowers, increase the "Outd.temp.delay on temp.drop" If the opposite occurs, lower the delay time.
Outd.temp.delay on temp.increase	2.0	0... 15 h	Typically 2 hours delay time is used in radiator heating. If room temperature decreases too much when outdoor temperatures increase below the freezing point, increase the setting value "Outd.temp.delay on temp.increase."
Anticipation of floor heating			
Floor heat. anticipate on temp.drop	2.0	0... 15 h	The anticipation drop of floor heating is in use, if the the floor heating is selected as a heating mode in the control circuit settings. Typically 2 hours delay time is used in floor heating. If room temperature falls too much when freezing temperatures fall further, increase anticipation. If the opposite occurs, lower anticipation.
Floor heat. anticipate on temp.incr.	2.0	0... 15 h	Anticipation of floor heating is used for stabilizing room temperature when outdoor temperature changes. In floor heating, the concrete mass of the floor slows transmission of heat from floor to room air temperature. If room temperature rises too much when temperatures rises in winter, increase anticipation.
Summer function			
Pump summer stop	In use	In use/ Not in use	If A203 controls also the pump, the pump can be stopped while the summer function mode is active.
Summer function outd. temp. limit	19.0	10 ... 35 °C	Summer function outdoor temperature limit. When the measured or forecast outdoor temperature exceeds the outdoor temperature limit of the summer function, the regulation valve closes and the circulation water pump stops (if valve summer shut-down is in use).
Summer function inhibition limit	6.0	-10...20	The summer function is turned off immediately if the real-time outdoor temperature falls to the "Summer function inhibition limit." The summer function is also turned off if room temperature falls at least 0.5°C below the value setting or when the A203 restarts.
Summer function off delay max	10	0...20h	The summer function switch off delay determines the starting time for heating. This helps avoid unnecessary heating during summer in case the outdoor temperature falls momentarily. The switch off delay is calculated as follows: [the duration of the summer function] x [summer function off delayfactor] (limited to the set max delay value). The switch off delay is reset if the room sensor is active and the room temperature drops more than 0.5 °C below the set value, or in the event of a power cut.
Summer function off delay factor	1.5	0.5...3.0	

Setting	Factory setting	Range	Explanation
Outdoor temp. forecast	Not in use	In use/ Not in use	A203 uses temperature forecasts from bus for continousing.
Valve summer shut-down	In use	In use/ Not in use	The setting is used to select whether or not the regulation valve is closed when the summer function is in use.
Valve summer flushing	In use	In use/ Not in use	If controller is in summer function mode the flushing operation is activated every Monday at 8.00. The controller opens the valve 20% open and then closed. If the controller also controls the circulation pump, the circulation pump is used during valve flushing.
Autumn drying			
Autumn drying status		On/Off	The screen shows whether or not the autumn drying is on. Data is informative.
Autumn drying	Not in use	In use/ Not in use	In autumn dry mode, supply water temperature is automatically raised for 20 days. The function is turned on automatically when the average daytime temperature has been more than 7°C for a minimum of 20 days and then falls below +7°C. The function remains on for the following 20 days if the outdoor temperature is below 7°C.
Effect of autumn dry			
Autumn dry effect on supply water	4.0	0... 25 °C	The setting value shows how much the autumn dry function raises supply water temperature. If room temperature is in use, the user sets how much the room temperature's setting value is increased.
Autumn dry effect on room temp.	1.0	0.0... 1.5 °C	
Room compensation			
Room compensation	In use	In use/ Not in use	It can defined whether room temperature affects to the control of supply water. If the measured room temperature differs from its setting value, room compensation corrects the temperature of the supply water. Room compensation will not be performed if the room temperature measurement is alarming (measurement is less than 1.0 °C with an alarm delay of 10 min).
Room temperature setting	21.5	5... 50 °C	Basic room temperature setting for the controller set by the user. This setting value is not visible unless room compensation is in use.
Room temp.measurement delay	2.0	0...2 h	Amount of room temperature measurement delay. Different buildings react to temperature changes at different rates. This setting value can reduce the effect of the building on the room temperature control.
Room compensation ratio		0...7	Coefficient used in applying the difference between room measurement and the room setting value to the supply water setting value. For example, if room temperature in radiator heating is one degree below the setting value, supply water is raised by four degrees.
Radiator heating	4.0		
Floor heating	1.5		
Comp. max.effect on supply water		0...25 °C	Room compensation's maximum effect on the supply water.
Radiator heating	16.0		
Floor heating	5.0		
Room comp.adjustm. time (I-time)		0.5 ... 7 h	Time correction improves the room compensation function (I-regulation). In massive houses or houses where floor heating has been installed on a concrete floor, longer room compensation correction times are used.
Radiator heating	1.0		
Floor heating	2.5		
I control's max effect on sup wat		0 ... 15 °C	Room compensation time correction can change supply water temperature to no more than this setting value. If room temperature continuously fluctuates, check whether the problem is resolved by lowering the setting value.
Radiator heating	3.0		
Floor heating	2.0		
Pumps			
Double pump function	backup pump	alternate pump/ backup pump	The other pump can function either as an alternate pump or as a backup pump. If you choose an alternate pump use, the pump operates alternately as a main pump and as a backup pump. The backup pump starts when the main pump fails.
Pumps run time period	7	1...365 days	In alternate pump use the pumps 1 and 2 are controlled by the controller to function on alternate time periods as a main pump and a backup pump. The alternate use is aimed at constant pump wear and a longer lifetime. The operation of the pumps is measured by a running time counter. At the changing point, the controller checks the run time of each pump from the running time counter to ensure that the use of the pump use is evenly divided between the pumps and, if necessary, to alternate the pumps.
Px.x Pump run time			Information to be read from the pump running time counter.
Px.x Reset run time counter	No	No/Yes	It is good to reset the running time counter when replacing the old pump with a new one.
Pump control	Auto-matic	Automatic/ Manual	If necessary, you can force the pump to manual control and select whether the pump is in on mode or in off mode.

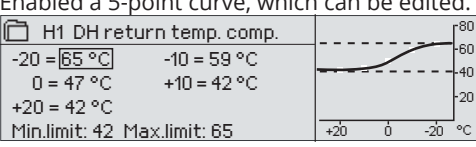
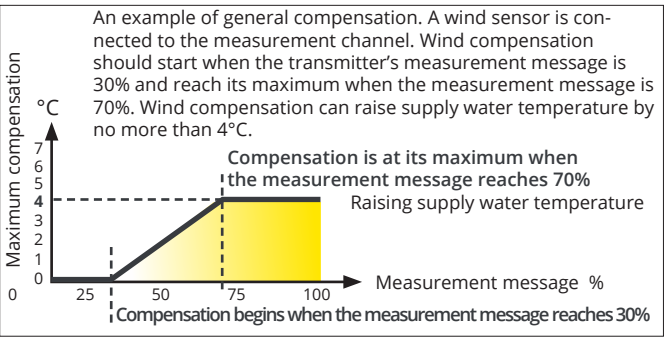
Setting	Factory setting	Range	Explanation
Return water compensation			
Return water compensation ratio	2.0	0 ... 7.0	If the return water temperature decreases below the low limit (freeze risk), the supply water temperature will be increased. The amount of increase is the amount of undershoot (low limit - return water temperature) multiplied by the compensation ratio.
DH return water compensation			
H1 (H2) DH return temp. comp.	Not in use	In use/ Not in use	The function, which drops the setting value of heating circuit supply water, if the DH return water temperature from the heat exchanger exceeds the value of the compensation curve which is proportional to outdoor temperature.
H1 (H2) DH return t. comp. curve.			Enabled a 5-point curve, which can be edited. 
Min. limit	42	20... 60 °C	When DH return water temperat. from heating exchanger is smaller than min. limit, the effect of DH retur water compensation is zero.
Max.limit	65	50... 70 °C	When DH return water temp. from heating exchanger is higher than max limit, the effect of DH retur water compensation affects always.
H1 (H2) DH ret. water comp. P-area	200	2... 500 °C	P-area of DH ret. water comp. in PI-control.
H1 (H2) DH ret. water comp. I-time	180	0 ... 300 s	I-time of DH ret. water comp. in PI-control.
H1 (H2) DH return temp. max comp .	20	0 ... 50 °C	The value by which DH Return compensation can affect in maximum to supply water setting.
Bus measurements			
Outdoor temperature from bus	Not in use	Not in use/ In use	A outdoor temperature measurement can be read either from bus or through M1.
H1 Room temp. from bus	Not in use	Not in use/ In use	A room temperature measurement specific to H1 control circuit can be read either from bus or through M4.
H2 Room temp. from bus	Not in use	Not in use/ In use	A room temperature measurement specific to H2 control circuit can be read either from bus or through M7.
General compensation			
General compensation	Not in use	Not in use/ In use	General compensation can increase or decrease the temperature of supply water. Transmitter measurement allows to utilize wind or solar measurement or pressure differential measurement over the heating network.
Compensation min	0	0 ...100 %	Setting limit values for a compensation area. Set the transmitter measurement message value at which compensation begins and the value at which it reaches its maximum level. The amount of compensation is linear between the limit values. (The transmitter is taken in use and setting values for the measurement area defined in the configuration of the particular measurement channel.)
Comp.reaches max on meas. signal	100	0 ...100 %	
Compensation min effect	0	-20 ... 20 °C	Minimum compensation defines how much the supply water temperature is changed when compensation begins.
Compensation max effect	0	-20 ... 20 °C	Maximum compensation defines the maximum amount that compensation can raise or lower supply water temperature. If wind measurement is used in transmitter measurement the setting value is positive, i.e. supply water temperature is raised due to the wind. If solar measurement is used in transmitter measurement the setting value is negative, i.e. supply water temperature is lowered due to solar radiation.
			<p>An example of general compensation. A wind sensor is connected to the measurement channel. Wind compensation should start when the transmitter's measurement message is 30% and reach its maximum when the measurement message is 70%. Wind compensation can raise supply water temperature by no more than 4°C.</p> 
44 Compensation filtering	5	0...300 s	Output signal filtering. The filtering attenuates the effect of rapid changes.

Setting	Factory setting	Range	Explanation
Bus compensation			
Bus compensation	Not in use	In use/ Not in use	The need for compensation can be specified by an external device to A203 through bus (e.g. Ounet S-compensation).
Supply water max. increase	8	0 ... 30.0 °C	Channel compensation cannot increase supply water temperature more than allowed by the setting value.
Supply water max. drop	-8	-30.0 ... 0 °C	Channel compensation cannot drop supply water temperature more than allowed by the setting value.
Alarm setting values			
Alarms	Enable	Disable/ Enable	It's possible to disable all alarms of A203. This can be done e.g. in the cases when the measurements are configured before any sensors are linked to controller. When alarms are disabled, a symbol  is shown in the start menu.
H1 (H2) Control circuit - Alarm settings :			
Supply water deviation alarm	10.0	1...50 °C	Amount of difference between measured supply water temperature and the supply water temperature set by the controller that causes an alarm when the deviation has continued for the entry delay time. A deviation alarm is not activated when the controller is in summer function mode, when the controller is not on automatic or when outdoor temperature is more than 10°C and supply water temperature is less than 35°C. The alarm allows for a 5 s delay.
Deviation alarm delay	60	1...120 min	The deviation alarm will be activated once the deviation has lasted for the defined time delay.
Supply water high limit alarm	80.0	40...100 °C	Supply water high limit alarm
High limit alarm delay	5	0...120 min	The high limit alarm is activated when the supply water temperature has exceeded the high limit longer than the defined delay time.
Return water freezing risk limit	8.0	5...25 °C	The return water freezing risk alarm is activated when return water temperature has remained below the freezing risk limit for longer than the allowed delay time. The exit delay for freezing risk alarm is 5 seconds.
Return water alarm delay	5	1...120 min	
DHW control circuit - Alarm settings:			
DHW over heating alarm limit	68	65...120 °C	The controller gives a domestic hot water alarm when the temperature of domestic hot water exceeds the preset overheating alarm limit or falls below the low limit alarm limit and the excess/drop has lasted the delay time of overheating/ low limit alarm. The exit delay of the alarms is 5 minutes. If either DHW increase or drop is in use, the alarm limits will change so that in increase/drop mode the alarm limit is always at least 5 degrees above/below the current DHW setting value.
DHW low limit alarm limit	40.0	20...70 °C	
DHW over heat./low limit alarm delay	10	0 ... 30 min	
PRESSURE MEASUREMENTS 1 and 2 have their own value settings.			
Pressure 1(2) low limit alarm	0.5	0...20 bar	A lower limit alarm is activated when the pressure measurement decreases below the lower limit of the pressure measurement set value. Alarm is deactivated when the pressure is 0.1 bar over the limit.
Pressure 1(2) high limit alarm	15	0 ... 20 bar	The controller gives the upper limit alarm when the pressure measurement is greater than the upper limit of the pressure set value. Alarm goes off when the pressure is 0.1 bar below the limit.
Alarm limits of temperature measurements UI 10 and UI11			
M10 (11) Entry delay	60	0...300 s	An alarm is activated, when the measured temperature has been under defined low limit or over high limit for longer than entry delay.
M10 (11) Alarm min limit	-51	-51...131 °C	Low limit alarm is activated, when the temperature drops below the defined low limit. The alarm is deactivated, when the temperature is 1.0 °C over the lower limit.
M10 (11) Alarm max limit	131	-51...131 °C	High limit alarm is activated, when the temperature increases above the defined high limit. The alarm is deactivated when the temperature is 1.0°C below the high limit.
Contact alarm of free measurements M10 and M11			
M10 (11) Alarm delay	30	0...300 s	Contact alarm is activated, when the entry delay has passed after an alarm activation.

Setting	Factory setting	Range	Explanation
Tuning values			
H1 and H2 Tuning values:			
P-area	200	2...600 °C	Supply water temperature change at which the actuator runs the valve at 100%. E. g. If the supply water temperature changes 10 °C and the P area is 200 °C the position of the actuator changes 5 % ($10/200 \times 100 \% = 5 \%$).
I-time	50	5 ... 300 s	The deviation in the supply water temperature from the set value is corrected by P amount in I time. For example, if deviation is 10°C, P-range is 200°C and I time is 50 s, the actuator will be run at 5 % for 50 seconds.
D-time	0.0	0 ... 10 s	Regulation reaction speed up in the event of a temperature change. Beware of constant oscillation!
Supply w. max.effect of change	4.0	0.5... 5°C/ min	The maximum speed at which the supply water can be raised when switching from a temperature drop to a nominal temperature. If the radiators knock, slow down the change rate (set the setting smaller).
Actuator running time open	150	10 ... 500 s	The running time indicates how many seconds go by when the actuator runs a valve nonstop from a closed position to an open position.
Actuator running time close	150	10 ... 500 s	The running time indicates how many seconds go by when the actuator runs a valve nonstop from a open position to an close position.
DHW Tuning values			
P-area	70	2 ... 500 °C	Supply water temperature change at which the actuator runs the valve at 100%.
I-time	14	5 ... 300 s	The deviation in the supply water temperature from the set value is corrected by P amount in I time.
D-time	0.0	0 ... 10.0 s	Regulation reaction speed up in the event of a temperature change. Beware of constant oscillation!
Anticipating	120	1....250 °C	Uses anticipation sensor measurement information to speed up regulation when DHW consumption changes. Increase the anticipation value to decrease reaction to changes in consumption.
Quick run	60	0 ... 100 %	Functions during consumption changes. Decrease this value to decrease reaction to quick temperature changes.
Actuator running time open	15	5 ... 500 s	The running time indicates how many seconds go by when the actuator runs a valve nonstop from a closed position to an open position.
Actuator running time close	15	5 ... 500 s	The running time indicates how many seconds go by when the actuator runs a valve nonstop from an open position to a close position.
Actuator running time close	15	5 ... 500 s	The running time indicates how many seconds go by when the actuator runs a valve nonstop from an open position to a close position.
Limit for P control Inhibition	5.0	0 ... 50 °C	If the measured temperature differs from the setting of the "Limit for P control inhibition" and the temperature change is toward the setting value, the P control is blocked for as long as the measured temperature reaches the "Limit for P control inhibition".

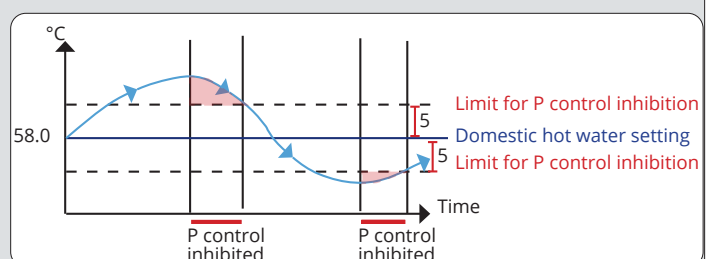

11 Restore settings and updates

Restore factory settings

Service	
Restore factory settings	>
Activate startup wizard	>
Restore backup	>
Create backup	>

When you reset the system to factory default settings, the regulator will revert to controlled start-up mode.

If you want to restore the current settings later, make a backup before restoring the factory settings.

Create backup

Create a backup, when A203 has been configured and the device-specific settings have been set.

If desired, also the factory settings can be restored to the device.

All the parameters which are saved in the non-volatile memory will be included in the backup. Such parameters are e.g. all the setting values and time programs. The backup is saved to the controller's internal memory.

Restore backup

To restore your own backup, select "Restore Backup".

The controller automatically creates backup every hour to the controller's internal memory. When you update the software, the controller restores the backup that it has created.

Activate startup wizard

Start up wizard	
Language	English >
Restore backup	>
Connections and configuration	>
Take selections into use	>

A new uninitialized device will start in startup mode. The inputs and outputs are activated in the configuration. When you have done the selections concerning the inputs and outputs, exit from the menu by pressing ESC. Go to menu "Take selections into use". The device will start and selected configuration is taken in use.

11.1 Update the software

The controller settings are saved and those returned automatically after software update. The controller automatically backs up every hour and automatically restores the backup to the controller after the software update.

If you want, also you can make a backup before the software update, and restore the backup after the software update.

1. Go to the WEB interface of the device from the browser (for more information on logging in, see page 49).
2. Go to the Device management tab.
3. Under SW update, click SELECT FILE.
4. Select the A203 x.x.x zip file and press Open. The file name will appear in the interface as well as the "Update" button.
5. Select "Update". The update may take 5-10 minutes.
6. When the update is complete, a message will appear: "File upload succeed. Please wait until the update takes effect!" Press the "Continue" button.
7. The message "Update succeed !. Press the "Main page" button to access the main page.

12 Remote control options



Use of a GSM phone requires that the GSM modem (optional) is connected to the controller.

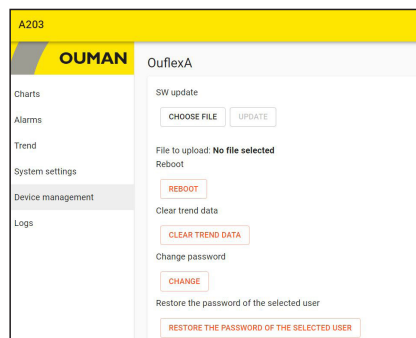

Web Server remote control and monitoring (optional).

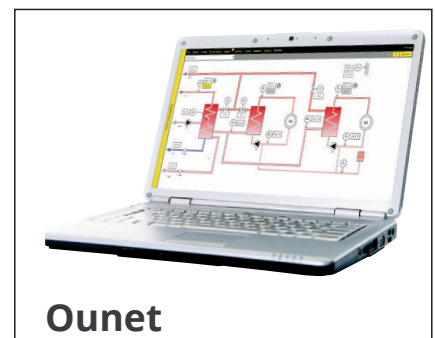

Ounet

Internet-based on-line control room for professional remote control and monitoring (optional).

12.1 Text message use

If a GSM modem is connected to the A203 you can communicate with the controller by text messages using command words.

Send the following text message to the controller: KEY WORDS.

If the controller has a device ID in use, always write the device ID in front of the key word (example. Ou01 KEY WORDS or Ou01 ?). **Capital and small letters are different characters in the device ID!**

The controller sends a list of key words as a text message that gives you information about the controllers' functions and state. The key word is separated by a /. You can write the key word using capital or small letters. Write only one key word per message. Store the key words into your phone's memory.

Key word	Explanation
?	Reply messages show all key words in the language that has been selected for the controller.
Key words	If the controller is set up in English, the regulator sends a list of key words.
Home	A203 goes into "Home" mode.
Away	A203 goes into "Away" mode.
Inputs	The measurement information or state of the input are shown in the reply message.
Outputs	The state of controls is shown in the reply message.
H1 Info H2 Info	The reply message shows the calculated setting value of supply water and factors which affect on it. Data are informational.
H1 Setting values H2 Setting values	The response message shows the "Temperature drop" and "Room temperature setting" if room temperature measurement is enabled.. You can change the setting values by modifying the text message and sending it back to A203. The controller confirms the setting change by replying with new settings.
H1 Control mode H2 Control mode	In the reply message, the current control mode will have a star next to it. You can change the mode for the circuit by moving the star and sending a change message to the controller.
H1 Heating curve H2 Heating curve	You can set temperatures for supply water for 5 outdoor temperatures. Two outdoor temperatures are fixed values (-20 and +20°C). You can change the three outdoor temperature setting values between these. You can also change the minimum and maximum limits of supply water.
DHW Setting values	The reply message will show the setting value for domestic hot water and its control mode. You can also change the setting and control mode.
DHW Info	The measurement information is shown in the reply message. You can also change the setting value of domestic hot water.
Active alarms	The reply message will show all active alarms.
Alarm history	The reply message will show information about the latest alarms.
Type info	The reply message will show information about the device and software.

Attention! If the controller has a device ID in use, always write the device ID in front of the key word

12.2 WEB UI

A203 includes an internal web server. You can access it using a browser. As all functions have been tested using Google Chrome, we recommend that you also use Chrome. You can use the browser on a PC, smartphone, tablet or a browser touch screen purchased from Ouman.

Check the Ouflex device's host name from the label (next to the device's Ethernet port) or from the device's network settings. When you use the host name to establish a device connection, remember that, if you establish the connection remotely across the internet, the final part of the name is ouman.net. If you establish a connection through a LAN from a device, featuring the Apple, Microsoft or Linux operating system, the final part of the host name is ouman.local. The Android operating system does not recognise addresses ending in "local". This is why you need to use the IP address when logging in from Android devices to LANs.

Enter the user ID and password. The device has three user ID levels: "service", "user" or "viewer". "Service" level users have the most extensive rights. This section presents the user rights assigned to "service" level users. "User" level users can edit settings and time programs. "Viewer" level users only have viewing rights, and a user ID-specific password can be changed for these users. **The device-specific password can be found from the A203 device's label. By default, all user IDs have the same password. Change the password!**

If you log in to the device locally, DiscoveryTool or Ouflex BA Tool must be installed on your PC.

Changing the password: Which user password can be changed?	service, user and viewer	user	viewer
To read charts and trends	X	X	X
To view and acknowledge alarms	X	X	X
To modify setting values and time programs	X	X	
To edit charts	X		
To create the trend groups and edit trends	X		
To change the control mode: automatic - manual control	X		
System settings	X		
Device management	X		
Log	X		

Read more about the WEB UI Ouflex A User manual at: www.ouman.fi/en/documents

Optional accessories

GSMMOD

By connecting the modem to the A203 you can communicate with SMS's to the controller and have information of activated alarms to GSM phone. The modem has a fixed antenna that can be changed to an external antenna with a 2,5m cord (optional equipment) if needed. The modem's indicator light shows what mode it is in.

Primary connection:

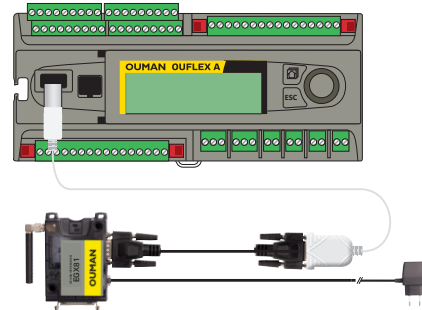

Secondary connection:

You can connect the modem to the A203 device's 15Vdc output, ensuring that the cumulative load does not exceed 750mA. Also, consider the power requirements when loading the 15Vdc output (see p. 56 Technical specifications).

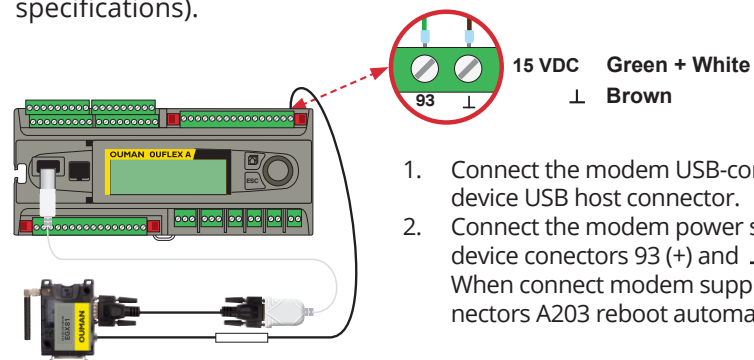

1. Connect the modem USB-connector to the device USB host connector.
2. Connect the modem power supply to the device connectors 93 (+) and ⊥. When connect modem supply to A203 connectors A203 reboot automatically.

Inserting the SIM card

Insert the SIM card into the SIM card holder on the end of the modem, with the contact surface facing the label on the top of the modem. Press in on the SIM card until it clicks into place and the card is firmly seated in the holder. The card can be removed from the bracket using a flat tool, such as a flat-blade screwdriver.

The PIN code of the A203 is set to the same code as the SIM card.



Surface thermostat C01A
AC 250V 15 (2,5) A

C01A

In floor heating solutions it is important to make sure that excessively hot water which could damage structures or surfaces doesn't ever get into the network. A mechanical thermostat should be installed on a supply water pipe which stops the circulation pump in case of overheating. Set the thermostat at 40 ... 45 °C. Set the A203 regulator's maximum limit between +35 ... +40 °C and the minimum limit between +20 ... +25 °C.

Product information and type label

Product:	Heat regulator for three circuits
Manufacturer:	Ouman Oy Linnunrata 14 FI-90440 Kempele FINLAND tel. +358 424 840 1 www.ouman.fi
Product name:	A203
Models:	A203
Version:	HW and SW version on the type label
Valid:	2024/03

There is a type label on the end of the device



Year/month of manufacture

The controller may have been updated from the factory after delivery. Check the valid type information on the controller screen (System settings → Type information).

Warranty information

The seller provides a 24-month warranty for the quality of the materials and workmanship of all delivered goods.

The warranty period begins on the date of purchase. In the event that material or workmanship defects are detected and the goods are sent, without delay or no later than by the end of the warranty period, back to the seller, the seller agrees to address the defect at their own discretion either by repairing the damaged goods or by delivering a new, defect-free goods, free of charge, to the buyer.

The buyer is responsible for the costs resulting from delivering the goods to the seller for warranty repairs, while the seller is responsible for the costs resulting from returning the goods to the buyer.

The warranty shall not cover damages resulting from accidents, lightning, floods or other natural events, normal wear and tear, inappropriate, negligent or unusual use of the goods, overloading, incorrect maintenance, or reconstruction, alteration and installation work which is not carried out by the seller (or their authorized representative).

The buyer shall be responsible for selecting material of equipment susceptible to corrosion, unless other agreements are signed. In the event that the seller alters the structure of their equipment, they shall not be obligated to make similar changes to previously procured equipment. The validity of the warranty requires that the buyer has fulfilled their contractual obligations related to the delivery.

The seller shall provide a new warranty for goods replaced or repaired under the original warranty. However, the new warranty shall only be valid until the expiration of the warranty period of the original goods. For any repairs not covered by the warranty shall be subject to a 3-month maintenance warranty covering the material and workmanship.

Product disposal



The enclosed marking on the additional material of the product indicates that this product must not be disposed of together with household waste at the end of its life span. The product must be processed separately from other waste to prevent damage caused by uncontrolled waste disposal to the environment and the health of fellow human beings. The users must contact the retailer responsible for having sold the product, the supplier or a local environmental authority, who will provide additional information on safe recycling opportunities of the product. This product must not be disposed of together with other commercial waste.

Index

- 5-point curve 11-12
- Access 29, 31
- Active alarms 4, 25
- Actuator running time 39, 46
- Actuator type selection 39
- Alarm disabled/enabled 45
- Alarm groups 24
- Alarm history 25
- Alarm priority 24-25
- Alarm recipients 25
- Alarm routing 25-26
- Alarms 5, 24-27
- Alarm setting values 45
- Alarm sound: on/off 27,4
- Alternate pump 35, 38, 39
- Automatic control 4, 14, 18
- Autumn dry 43, 13
- Away control 7, 8, 38

- Backup 47
- Backup pump 35, 38, 39
- Basic view 2
- Browser use 49
- Bus compensation 45
- Bus device connections 36
- Bus measurements 44

- Calculated room temperature setting 10
- Calibration 4
- Changing language 27
- Changing locking code 32
- Circulation water temperature 17, 33
- Compensation functions 43-45
- Connections and configuration 33-40
- Continious normal temperature 14
- Continious temperature drop 14
- Contrast 32
- Control mode 14, 18
- Cooling thermostat 21, 22, 35, 40

- Date setting 27
- Defrosting thermostat 21, 22, 35, 40
- Delayed outdoor temp. measurem. 10, 42
- Delayed room temp. measurement 10, 43
- Deviation alarm 45
- Device ID 28
- DHW Circulation/anticipation 17, 33
- Display settings 32
- Disposal 54
- District heat return temp. 7, 33
- District heat supply temp. 7, 33
- Domestic hot water anticipation 17, 33
- Domestic hot water control 17-21, 7
- Domestic hot water reduction/incr. 17, 19-20
- Domestic hot water low limit alarm 45
- Domestic hot water overheat alarm 45

- Energy measurement 7, 33, 38
- Exception schedule 16, 20

- Floor heating anticipation 42, 43
- Forced control 14, 18
- Free temperature meas. 33, 37

- General alarms 38, 45
- General compensation 44
- General measurements 7, 34, 37-38
- GSM-modem 28, 50

- Heating control circuits 9-16, 41
- Heating curves 11-12, 44
- Heating mode 41, 12
- Heating thermostat 21, 22, 35, 40
- Home-Away-control 7, 8, 38

- Info 9-10, 17
- Inputs and outputs 7-8, 37-40
- IP-address 29-30

- Key words 48

- Language selection 27
- Locking code 32
- Locking settings 32

- Magnetic valve control 35
- Manual use 14, 18, 39
- Measurement adjustment 37
- Measurements (inputs) 10, 17, 37, 38
- Measurement labelling 40
- Modbus RTU settings 30
- Modbus RTU connections 36
- Modbus TCP/IP settings 30
- Modem connection 28, 33
- Modem status 28

- Naming 40
- Network settings 29-31

- Ounet 48, 310
- Outdoor temperature 7, 33, 37, 44
- Outdoor temperature delay 42, 43
- Outputs 8, 39

- Parallel shift 41
- PID 46
- PIN 28
- Pre increase 42
- Pressure alarms 45
- Pressure measurement 34, 38
- Product information and type label 52
- Protection class 52
- Pump alarm 33, 38
- Pump control 35, 39
- Pump running counter 39
- Pump running info 33, 7

- Radiator heating delay function 42
- Relay control 21-22, 35, 39
- Remote use 48
- Restore backup 47
- Restore factory settings 47
- Return water compensation 37, 44
- Return water freezing risk alarm 45
- Return water temperature 7, 37
- Room compensation 43
- Room I control 43
- Room temperature info 10
- Room temp. sensor connection 33, 34
- Room temperature setting 13, 43

- Sensor fault alarms 24
- Setting values 13, 17, 41-46
- Signal strength 28
- SIM card 28, 49
- SMS settings 28
- SMS use 48
- SNMP settings 30
- Special days 16, 20
- Sum alarm 40
- Summer function 42, 13
- Supply water pre-increase 42
- Supply water temperature 7, 10, 11
- Supply water temperature info 9
- Supply water temp. max limit 11, 12, 41
- Supply water temp. min limit 11, 12, 41
- System settings 27-32

- Technical information 56
- Temperature drop 41, 9-10, 17-22
- Temperature measurem. adjustment 36
- Textmessage kommunikation 49
- Time programs 15-16, 19-22, 26
- Time setting 27
- Transmitter measurement 37
- Trend 23, 18
- Trend log sampling interval 23
- Tuning values 46
- Type information 32, 48

- Updating 48

- Valve flushing 43
- Valve summer shut-down 43

- Warranty information 53
- Water volume measrument 7, 33, 38
- Web UI 50
- Weekly schedule 15, 19, 22, 26

Dimensions	width 213,5 mm, height 93,3 mm, depth 96,8 mm
Weight	0.7 kg
Protection class	IP 20
Operating temperature	0 °C...+40 °C
Storing temperature	-20 °C...+70 °C
Power supply	
Operating voltage	24 Vac, 50 Hz (22 Vac - 33 Vac)
Power required	(15 Vdc output =if not connected) 13 VA (15 Vdc output = 750 mA) 34 VA In addition, the operating voltage of 24 Vac and the power requirement of the Triac outputs must be taken into attention. Maximum total current limit is 4A. Then maximum supply power need is 96 VA.(Max 1A/triac pair)
Backupinput	12 Vdc
Current consumption	300mA / 3,6W (relays not in use), 400mA / 4,8W (relays in use)
Universal measurement input (can be configured) measurement types:	
Passive sensors (inputs 1...13)	Measurement channel accuracy: <ul style="list-style-type: none"> • NTC10: +0,1 °C between -50 °C...+100 °C , +0,25 °C between +100 °C...+130 °C • NTC 1.8 ±0,2 °C between -20 °C...+40 °C, +0,6 °C between +40 °C...+70 °C and +2.0 temp. over 75 °C. • NTC 2.2: ±0,2 °C between -20 °C...+55 °C, +0,5 °C between +60 °C...+70 °C and +2.0 temp. over 75 °C. • NTC 20: ±0,1 °C between -20 °C...+70 °C, ±0,6 °C between +75 °C...+120 °C • Ni1000 LG: +1,0 °C between -50 °C...+130 °C • Ni1000DIN: ±0,2 °C between 100 °C...+130 °C, +0,5 °C between -5 °C...-20 °C • PT1000 element: +1,0 °C between -50 °C...+130 °C Also sensor tolerances and the effect of cables must be considered when calculating total accuracy.
Active sensors (inputs 4, 7, 12-14)	0...10 V voltage message, meas. accuracy 1 mV Milliampere signal with 250Ω shunt resistor 0-20 mA
Contact information (inputs 10...16)	Contact voltage 5 Vdc. Contact current 0,5 mA Contact resistance max 1,9 kΩ (closed), min 11 kΩ (open)
Digital input measurement types:	
Contact information (inputs 21 and 22)	Contact voltage 15 Vdc. Contact current 1,5 mA Contact resistance max 500 Ω (closed), min 1,6 kΩ (open)
Counter inputs (inputs 21...22)	Minimum pulse length 30 ms
Analog outputs (61...66)	Output voltage range 0...10 V. Output current max 10 mA/output.
Relay output	
Change-over contact relay (71...76)	2 pcs, 230 V, 6 A
Normally open contact relay (77...84)	4 pcs, 230 V, 6 A
Triac outputs	
24 Vac (42 and 43)	Output current together max 1 A
24 Vac (44 and 45)	Output current together max 1 A
Operating voltage outputs	
5 pcs 24 Vac outputs (41)	Output current max 1 A /output
15 Vdc output	Output current max 750 mA
Data transfer connections	
RS-485 bus (A1 and B1)	Galvanically isolated, supported protocols Modbus-RTU (COM2, Modbus master)
RS-485 bus (A2 and B2)	Galvanically isolated, supported protocols Modbus-RTU (COM3, Modbus slave)
USB-host connection	RS-232-modem (GSMMOD)
Ethernet	Full-duplex 10/100 Mbit/s, supported protocols Modbus-TCP/IP
Ouman Access	Intelligent remote connection built-in for use with Ounet.
APPROVALS	
EMC: Emission	EN 61000-6-3:2020 (EN55022B)
Immunity	EN 61000-6-1:2016 (IEC 61000-4-2, IEC 61000-4-3, IEC 61000-4-4, IEC 61000-4-5, IEC 61000-4-6, IEC 61000-4-11)
Safety:	EN 60730-1:2011
EMC-directive	2014/30/EU and the amending CE Directive 93/68/EEC
Low Voltage Directive:	2014/35/EU and the amending CE Directive 93/68/EEC
RoHS Directive	2011/65/EU and 2015/863/EU
WEEE	DIRECTIVE 2012/19/EU Waste Electrical and Electronic Equipment

Ouman products do not contain harmful substances defined in the REACH regulation, excluding the products that are listed on the website behind the attached QR code.

www.ouman.fi

